

# Year 8

# Knowledge Organiser

# January - April 2025

AMBITION, CONFIDENCE, CREATIVITY,  
RESPECT, DETERMINATION

Proud to be  
part of the  
 GREENSHAW  
LEARNING TRUST



---

### Why do we have knowledge organisers?

Knowledge organisers are a collation of the basic essential knowledge for success in each subject area that will underpin your learning for the term.

They are designed to provide the information you will need to be committing to your long term memory through recall exercises in Low Stakes Quizzing.

### How do we use knowledge organisers?

You should be using these KOs to create your homework quizzes so that you are practising retrieving information.

1. You can do this by testing yourself on the definition of key terms (both recalling the key term and then swapping to recall the definition), practice labelling diagrams, retrieves reasons and justifications for the main learning points.
2. They can also be used for 'memory dumps' where you try to recall as much of the information about a topic as possible and then use the KP to fill in the gaps.
3. They can also be used in class to assist with retrieval of the core knowledge needed for each subject.

You should have these with you at all times in school and out on your desk in all lessons.

If you lose your KO or it becomes too dishevelled, please purchase a new one from the Head of Year or the School Office.

Contents	
English	Page 1
Mathematics	Page 3
Science	Page 6
History	Page 17
Geography	Page 21
French	Page 24
Spanish	Page 27
RE	Page 29
DT:Food	Page 31
Art	Page 34
Drama	Page 36
PCSHE	Page 38
Computer Science	Page 41

**AMBITION, CONFIDENCE, CREATIVITY,  
RESPECT, DETERMINATION**

Proud to be  
part of the  
**GREENSHAW**  
LEARNING TRUST



# Year 8 Term 2 English The Fragile Mind Knowledge Organiser

## Hamlet

**The plot:** The ghost of the King of Denmark tells his son Hamlet to avenge his murder by killing the new king, Hamlet's uncle. Hamlet feigns madness, contemplates life and death, and seeks revenge. His uncle, fearing for his life, also devises plots to kill Hamlet.

### Key vocabulary:

#### Betrayal

The act of deceiving someone or letting them down

#### Power

Control or authority

#### Parenthesis

The addition of extra information in the middle of a main clause. This is surrounded by commas, brackets or dashes.

#### Grief

Extreme mental suffering caused by death or a loss

#### Sanity

The ability to be able to think or behave normally and reasonably (Insanity is the reverse)

#### Distress

Anxiety, sorrow or pain

#### Disempower

To take away someone's power

#### Regicide

To kill an ordained king or queen

#### Revenge

inflict hurt or harm on someone for an injury or wrong done to oneself

## King Lear

**The plot:** King Lear divides his kingdom among the two daughters who flatter him and banishes the third one who loves him. His eldest daughters both then reject him at their homes, so Lear goes mad and wanders through a storm. His favourite daughter is killed for treason and he is heartbroken at her death.

### Key vocabulary:

#### Hubris

excessive pride or self-confidence

#### Hamartia

Fatal flaw in a character which leads to it's downfall

#### Semi-colon

Used to join two main clauses that are linked in meaning to create a compound sentence

#### Diacoep

When a writer repeats a word or phrase with one or more words in between

#### Rejection

The act of pushing someone or something away

#### Turmoil

A state of confusion, disturbance or anxiety

#### Epizeuxis

A rhetorical device in which the words or phrases are repeated in quick succession, one after another, for emphasis.

#### Anaphora

Repetition at the beginning a phrase or clause

#### Epistrophe

Repetition at the end of a phrase or clause

## Frankenstein:

**The Plot:** Frankenstein looks at what happens when one man decides to play God. His actions ultimately lead to his own downfall. Gifted scientist Victor Frankenstein succeeds in giving life to a being of his own creation. However, this is not the perfect specimen he imagines that it will be, but rather a hideous creature who is rejected by Victor and mankind in general. The Monster seeks its revenge through murder and terror.

### Key Vocabulary:

#### Metaphor

Comparing two things by saying one thing is another

#### Foreshadowing

Hints given by a writer towards a future event.

#### Epigraph

A short quotation, phrase or saying given at the beginning of a book or chapter

#### Classical allusion

A reference to another story, in this case the myth of Prometheus. Shelley referred to her novel as 'The Modern Prometheus'

#### Galvanism

Early 19<sup>th</sup> century science which attempted to return life through the use of electrical current.

#### Prejudice

An unwarranted negative view due not based on reason or experience.

## Hamlet

**The plot:** The ghost of the King of Denmark tells his son Hamlet to avenge his murder by killing the new king, Hamlet's uncle. Hamlet feigns madness, contemplates life and death, and seeks revenge. His uncle, fearing for his life, also devises plots to kill Hamlet.

### Key vocabulary:

**Betrayal** The act of deceiving someone or letting them down

**Power** Control or authority

**Parenthesis** The addition of extra information in the middle of a main clause. This is surrounded by commas, brackets or dashes.

**Grief** Extreme mental suffering caused by death or a loss

**Sanity** The ability to be able to think or behave normally and reasonably

**Distress** Anxiety, sorrow or pain

**Disempower** To take away someone's power

## King Lear

**The plot:** King Lear divides his kingdom among the two daughters who flatter him and banishes the third one who loves him. His eldest daughters both then reject him at their homes, so Lear goes mad and wanders through a storm. His favourite daughter is killed for treason and he is heartbroken at her death.

### Key vocabulary:

**Hubris** excessive pride or self-confidence

**Semi-colons** are used to join two main clauses that are linked in meaning

**Diacope** when a writer repeats a word or phrase with one or more words in between

**Rejection** the act of pushing someone or something away

**Turmoil** a state of confusion, disturbance or anxiety

**Epizeuxis** rhetorical device in which the words or phrases are repeated in quick succession, one after another, for emphasis.

## Frankenstein:

**The Plot:** Frankenstein tells the story of gifted scientist Victor Frankenstein who succeeds in giving life to a being of his own creation. However, this is not the perfect specimen he imagines that it will be, but rather a hideous creature who is rejected by Victor and mankind in general.

**Metaphor** Comparing two things by saying one thing is another

**Foreshadowing** Hints given by a writer towards a future event.

**Epigraph** A short quotation, phrase or saying given at the beginning of a book or chapter

## Poetry key terms:

- **Free Verse** A form of poetry that doesn't make use of a rhyme or a rhythm
- **End-stopped lines** A line in poetry that ends with punctuation such as a dash, comma, colon, semi-colon or full-stop
- **Half-rhyme** type of rhyme formed by words that have a similar but not identical sound.
- **Dramatic Monologue** A poem written in the form of a speech given by an individual character
- **Prepositional phrases** a group of words that show the position of something. Often, the phrase begins with a preposition
- **Rhyming couplets** A pair of lines in a verse that rhyme.
- **Exclamative** A sentence that ends with an exclamation mark to so show a strong emotion like anger or surprise.
- **Enjambment** When lines from one verse run into another without ending with punctuation
- **Caesura** A stop or pause in a line of poetry, often indicated by punctuation
- **Rhetorical Question** A question that's posed that doesn't require or expect an answer
- **Assonance** The repetition of vowel sounds
- **Consonance** The repetition of consonant sounds
- **Internal Rhyme** Rhyme that occurs within a single line of verse or across multiple lines
- **Iambic pentameter** A rhythm that uses 10 syllables and mimics the rhythm of a heartbeat
- **Pronoun** Words that are used instead of nouns that refer to people.
- **Stanza** The literary term for a verse

## Significant figures

### Topics

- Rounding integers using significant figures (M994)
- Rounding decimals using significant figures (M131)
- Estimating calculations (M878)

### Keywords

Rounding - making a number simpler but keeping its value close to what it was.

Significant figures - the digits that are meaningful (e.g. the digits 3 and 4 in 3400 and 0.00034).

Estimate - working out an answer using rounded numbers to make the calculation easier.

## Coordinates and midpoints

### Topics

- Calculating midpoints (M622)
- Mixed problems: Coordinates and midpoints (M311)

### Building Blocks

- Reading and plotting coordinates (M618)

### Keywords

Midpoint - the middle point between two points.

Vertical - up and down  $\updownarrow$ .

Horizontal - left and right  $\leftrightarrow$ .

Line segment - a part of a line.

Coordinate - a point on the coordinate system written as  $(x, y)$ .

Vertices - corners of a shape, where two or more edges meet.

## Area and units

### Topics

- Finding the area of parallelograms (M291)
- Finding the area of trapeziums (M705)
- Converting units of area (M728)

### Building Blocks

- Finding the area of rectangles (M390)
- Finding the area of compound shapes (M269)
- Finding the area of triangles (M610)
- Finding the area of compound shapes containing triangles (M996)
- Converting units of length (M772)

### Keywords

Parallelogram -  $b \times h$  where  $b$  is the base and  $h$  is the perpendicular height.

Trapezium -  $\frac{1}{2} \times (a + b) \times h$  where  $a$  and  $b$  are parallel sides and  $h$  is the perpendicular height.

Parallel - lines in the same direction that never meet.

## Area and circumference

### Topics

- Identifying parts of circles (M595)
- Finding the circumference of circles (M169)
- Finding the area of circles (M231)

### Building Blocks

- Calculating with roots and powers (M135)
- Substituting into algebraic formulae (M208)
- Rounding decimals (M431)

### Keywords

Circumference =  $\pi \times \text{diameter}$

Area =  $\pi \times \text{radius}^2$

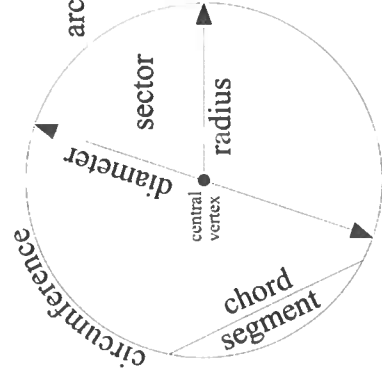

## Standard form and ordinary numbers

### Topics

- Using standard form with positive indices (M719)
- Using standard form with negative indices (M678)

### Building Blocks

- Multiplying and dividing by 10, 100 and 1000 (M113)

### Keywords

Ordinary form - number in whole number or decimal form.

Standard form - number between 1 and 10 multiplied by a power of 10 with index form.

Ascending - increasing in size.

Descending - decreasing in size.

## Venn diagrams

### Topics

- Venn diagrams (M829)
- Probabilities from Venn diagrams (M419)

### Building Blocks

- Writing probabilities as fractions (M941)
- Writing probabilities as fractions, decimals and percentages (M938)
- Probabilities of mutually exclusive events (M755)

### Keywords

Region - a section of the venn diagram.

Probability - likelihood of an event happening, given as fractions or decimals.

Frequency - the number of times something is happening. This is an integer.

## Factors, multiples and primes

### Topics

- Finding the HCF and LCM using prime factor decomposition (M365)

### Building Blocks

- Venn diagrams (M829)
- Finding the lowest common multiple (M227)
- Finding factors and using divisibility tests (M823)
- Finding the highest common factor (M698)
- Finding prime numbers (M322)
- Prime factor decomposition (M108)

### Keywords

HCF - Highest Common Factor.

LCM - Lowest Common Multiple.

Prime number- number that is only divisible by 1 and itself (2, 3, 5, 7, 11, 13 ...).

Product of prime factors (prime decomposition) - write a number as its prime factors multiplied together (e.g.  $12 = 2^2 \times 3$ ).

Index form - collecting together numbers that are multiplied together (e.g.  $4 \times 4 \times 4 = 4^3$ ).

## Nets and Surface Area

### Topics

- Properties of 3D shapes (M767)
- Nets of 3D shapes (M518)
- Finding the surface area from a net (M884)
- Finding the surface area of cubes and cuboids (M534)
- Finding the surface area of prisms (M661)

### Building Blocks

- Shape properties (M276)
- Nets of 3D shapes (M518)
- Finding the area of compound shapes (M269)
- Finding the area of compound shapes containing triangles (M996)
- Converting units of length (M772)

### Keywords

Face - the individual flat surfaces of a 3D shape.

Vertices - the corners of a shape.

Edge - a line joining the corners of a shape.

Prism - A 3D shape with two identical ends and flat sides.

Surface area - the total area of the surface of a 3D shape.

## Volume

### Topics

- Finding the volume of cubes and cuboids (M765)
- Finding the volume of prisms (M722)
- Converting units of volume (M465)

### Building Blocks

- Finding the area of compound shapes (M269)
- Finding the area of compound shapes containing triangles (M996)
- Converting units of length (M772)

### Keywords

Volume of a cuboid - length x width x height.

Cross-sectional area - area of a two-dimensional shape that is obtained when a three-dimensional object is sliced perpendicular (in a right angle).

## Year 8 Biology Knowledge Organiser Bioenergetics - Respiration page 1

### Box 1 - Respiration

- Cellular respiration is a **life process** that takes place **all the time (continuously)** in **every cell of all living organisms** (animals, plants, fungi, bacteria).
- It is necessary to **transfer/release energy** from **glucose** so that the cell can perform all other functions and processes.
- Organisms need energy** so that they can:
  - Synthesise (build) larger molecules from smaller ones**
    - Amino acids are built into proteins in plants and animals
    - Glucose is built into cellulose which is for new plant cell walls
  - Move** – Energy is required for muscles to contract in order for animals to move. Energy is also needed for individual cells to move (e.g. sperm cell swimming)
  - Transport certain materials.**
    - Energy is needed to transport essential minerals from the soil into plant roots.
    - Energy is needed to transport glucose from the small intestine into the blood in animals
- Keep warm** – Some energy is transferred from glucose to the thermal energy store of animals and birds therefore maintaining an ideal body temperature.

### Box 2 - Aerobic Respiration

- This type of cellular respiration takes place when oxygen is present.
- Glucose is oxidised by oxygen and forms carbon dioxide and water as waste products.
- Glucose is a store of chemical energy. Energy is stored in the bonds joining together the atoms that make up glucose.
- During the reaction when those bonds are broken and reformed into the waste products energy is transferred to the cell.

The **word equation** for aerobic respiration is:

Glucose + Oxygen → Carbon dioxide + Water (*and energy is transferred*)

The **symbol equation** for aerobic respiration is:

$C_6H_{12}O_6 + 6O_2 \rightarrow 6CO_2 + 6H_2O$  (*and energy is transferred*)

- Aerobic respiration transfers 19 times more energy to the cell than anaerobic respiration for every molecule of glucose.

Key Terms	Definitions
Respiration	This is a life process. It is a reaction that is carried out continuously by all living organisms (animals, plants, fungi and bacteria) to transfer/release energy from glucose. It occurs in every cell all the time.
Aerobic respiration	Respiration that occurs when oxygen is present
Anaerobic respiration	Respiration that occurs when there is insufficient (not enough) oxygen for aerobic respiration
Glucose	A simple sugar compound used in respiration that is a chemical store of energy
Cytoplasm	Jelly-like substance in all cells where cell reactions take place
Mitochondria	Cell organelles where aerobic respiration occurs
Lactic acid	A waste product of anaerobic respiration in animals that causes muscle fatigue. Oxygen is needed to convert it into carbon dioxide and water which are then excreted.
Muscle fatigue	In humans, this is a decrease in the ability of a muscle to produce a force – brought on by exercise
Yeast	A microscopic single-celled fungus
Fermentation	Anaerobic respiration that occurs in yeast producing ethanol, carbon dioxide as waste products
Ethanol	A type of alcohol

### Box 3 - Where does cellular respiration take place?

Anaerobic respiration takes place in the cytoplasm of cells when there is insufficient oxygen present.

If oxygen is present, the first part of aerobic respiration takes place in the cytoplasm and then finishes in the mitochondria.

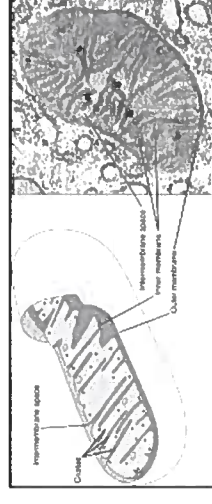

Mitochondria – diagram and micrograph

## Year 8 Biology Knowledge Organiser Bioenergetics - Respiration page 2

### Box 4 - Anaerobic Respiration

- This type of cellular respiration takes place when there is insufficient oxygen present for aerobic respiration.
- It enables some energy to be transferred to the cell from glucose when there is no oxygen.
- In animals, lactic acid is formed as a waste product of anaerobic respiration.
- In yeast and plant cells, ethanol and carbon dioxide are formed as waste products of anaerobic respiration.
- There is a lot less energy transferred by anaerobic respiration compared to aerobic respiration.

The **word equation** for anaerobic respiration in **animals**:

Glucose → Lactic acid (*and some energy is transferred*)

The **word equation** for anaerobic respiration in **Yeast and Plant Cells**:

Glucose → Ethanol + Carbon dioxide (*and some energy is transferred*)

### Box 5 - Anaerobic Respiration in Yeast and Plants

- Yeast are single-celled fungi who can respire with or without oxygen.
- Plants sometimes use anaerobic respiration if their roots get waterlogged. The root cells cannot access oxygen and so respire anaerobically.

Glucose → Ethanol + Carbon dioxide (*and energy is transferred*)

- This type of anaerobic respiration can also be called fermentation.
- We use fermentation of yeast to produce ethanol when used in brewing beer and carbon dioxide (CO<sub>2</sub>) when used in bread making (CO<sub>2</sub> makes bread rise).



Yeast Cells

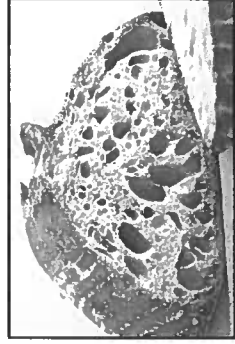

Bread risen by CO<sub>2</sub>

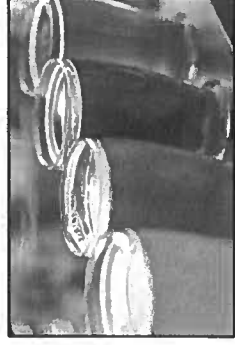

Alcohol made by fermentation

### Box 6 - Anaerobic Respiration in Animals

- In animals, anaerobic respiration occurs in cell as a result of strenuous exercise.
- During strenuous exercise, muscles are contracting to move limbs. The energy for this contraction is supplied by aerobic respiration of glucose in muscle cells.
- As exercise increases, the heart rate and breathing rate increase in order to transport oxygen to the muscle cells.
- If the supply of oxygen is not enough, respiration takes place without it – anaerobic respiration – and lactic acid is formed.
  - Glucose → Lactic acid (*and energy is transferred*)
- The build up of lactic acid in muscles causes fatigue. The muscles cannot contract as efficiently and produce less force with each contraction.
- Oxygen is needed in order to remove the lactic acid. Once oxygen is available, the lactic acid is converted back to glucose in the liver.

### Box 7 - Investigating Yeast Fermentation

- Yeast is a living organism that can survive at a range of temperatures.
- We can grow cultures of yeast in a liquid and use this culture to investigate what affects the rate of fermentation in yeast.
- We can measure how fast the fermentation reaction is in yeast by measuring how much carbon dioxide (CO<sub>2</sub>) is produced per minute when we change the growth conditions. The higher the rate, the better the yeast is growing.
- Conditions that can be changed include the temperature that the yeast culture is grown, the concentration of glucose in the liquid growth medium, the type of sugar in the liquid growth medium

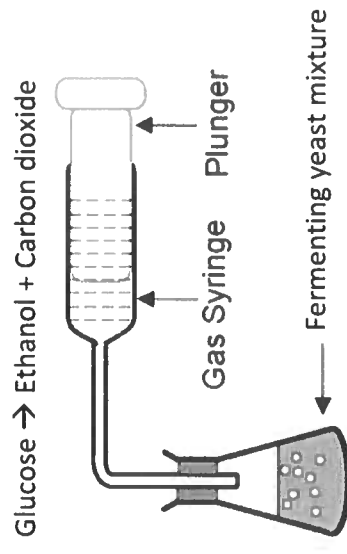

# Year 8 Biology Knowledge Organiser

## Organisation – Transport

### Box 1 - Diffusion

Diffusion is the **spreading out of the particles** of any substance in solution or a gas from an area of **higher concentration to a lower concentration**.

Substances can move into or out of cells across the cell membrane by diffusion.

**Oxygen and glucose** usually move into cells by diffusion. **Carbon dioxide and waste (urea)** usually move out of cells by diffusion. The bigger the surface area the faster the rate of diffusion.

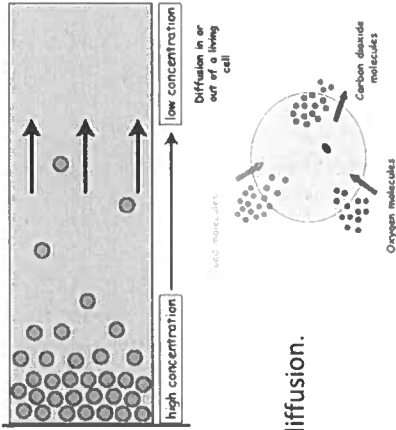

### Box 2 – The Lungs

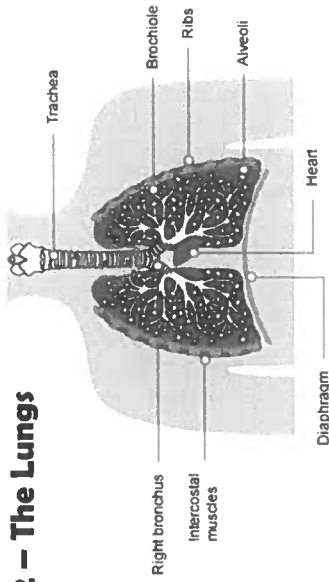

When we breathe in, air enters the lungs; it travels through the trachea, bronchi, bronchioles then into the alveoli. The trachea is held open by rings of cartilage to stop it collapsing when the neck is moved and bent.

The trachea and the bronchi are lined with ciliated epithelial cells and mucus. When we breathe, dust and microorganisms in the air stick to the mucus. The cilia “beat” to move the dirty mucus up and out of the lungs and it is then swallowed.

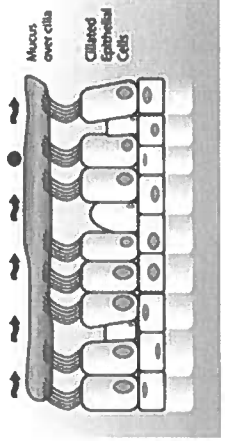

### Box 3 - Breathing

Breathing is caused by the intercostal muscles between the ribs and the diaphragm.

**Breathing in** is also called **inhaling** and occurs when:

- Intercostal muscles contract and move the ribs up and out.
- Diaphragm contracts and flattens.

This increases the volume inside the thorax and decreases the pressure in the thorax which draws air into the lungs.

**Breathing out** is also called **exhaling** and occurs when:

- Intercostal muscles relax and move the ribs down and in.
- Diaphragm relaxes and bulges upwards.

This decreases the volume inside the thorax and increases the pressure in the thorax which pushes the air out of the lungs.

### Key Terms

Key Terms	Definitions
Cilia	Microscopic hair like structures that cover the cells in the trachea and bronchi.
Alveoli	Microscopic air sacs in the lungs where gas exchange by diffusion occurs.
Gas exchange	The swapping of oxygen and carbon dioxide between the alveoli and the blood.
Thorax	Upper part of body including the rib cage, lungs and heart.

### Box 4 - Gas exchange

The lungs contain millions of microscopic alveoli. These are tiny air sacs that are just one cell thick and are surrounded by tiny blood vessels called capillaries.

The movement of oxygen and carbon dioxide is called gas exchange.

- The millions of tiny alveoli give a large surface area for diffusion.
- The walls of the alveoli are very thin so the substances don't have far to diffuse.

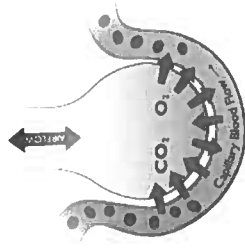

### Box 5 - Asthma

Asthma is a disorder where the muscles in the walls of the airways become swollen and inflamed and the muscles in the airways contract and the tubes become narrow.

This makes it hard to breathe out.

The triggers for asthma include dust, pollen, exercise and smoke. Inhalers make the muscles relax so the airways widen.

#### Inhalation

#### Exhalation

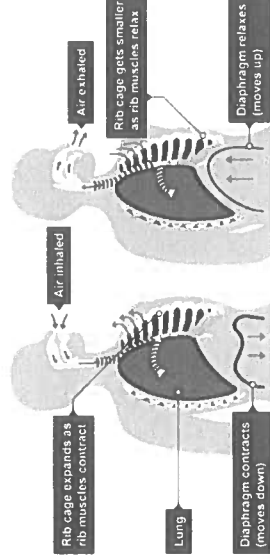

### Box 6 - Smoking

Cigarette smoke contains:

- Tar (which can cause lung cancer)
- Carbon monoxide (which reduces the amount of oxygen the blood can carry and causes breathlessness)
- Nicotine (which is addictive).

Smoking damages the cilia, which leads to a smokers cough.

# Year 8 Biology Knowledge Organiser

## Organisation – Transport

### Box 7 - The Circulatory System- The Heart

The circulatory system includes the heart, blood vessels and blood. The function of the circulatory system is to transport substances around the body.

The heart muscle contracts to pump blood around the body.

Heart muscle is a unique type of muscle because it doesn't tire.

The heart has four chambers called the

- left atrium
- right atrium
- left ventricle
- right ventricle

The right side of the heart pumps deoxygenated blood to the lungs.

The left side of the heart pumps oxygenated blood to the head and body

The heart is a **double pump**, with double circulation (one side of the heart pumps blood to the lungs and the other pumps blood to the head and body)

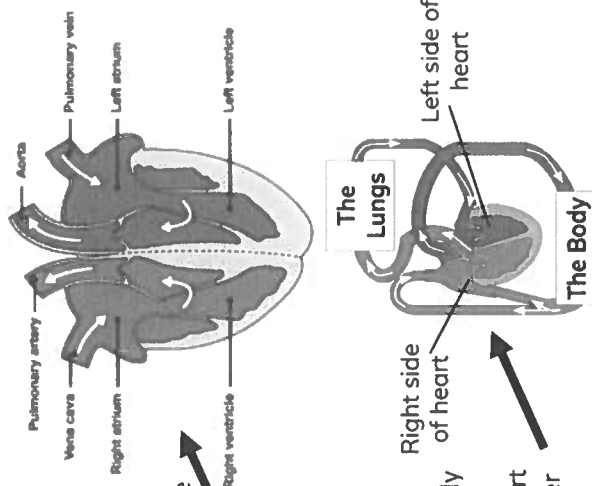

The heart muscle contracts to pump blood around the body.

Heart muscle is a unique type of muscle because it doesn't tire.

The heart has four chambers called the

- left atrium
- right atrium
- left ventricle
- right ventricle

The right side of the heart pumps deoxygenated blood to the lungs.

The left side of the heart pumps oxygenated blood to the head and body

The heart is a **double pump**, with double circulation (one side of the heart pumps blood to the lungs and the other pumps blood to the head and body)

Key Terms	Definitions
Circulatory system	Heart, blood vessels and blood that are involved in transporting substances around the body.
Oxygenated blood	Blood containing oxygen.
Deoxygenated blood	Blood that doesn't contain oxygen.
Transpiration	The loss of water from the surface of plants that occurs by evaporation.

### Box 9 - The Circulatory System- Blood

Blood is made up from red blood cells, white blood cells, platelets floating in a pale yellow liquid called plasma.

- **Red blood cells** carry oxygen around the body.
- **White blood cells** are part of the immune system and are involved in fighting disease .
- **Platelets** are needed for blood clotting.
- **Plasma** transports dissolved glucose and carbon dioxide.

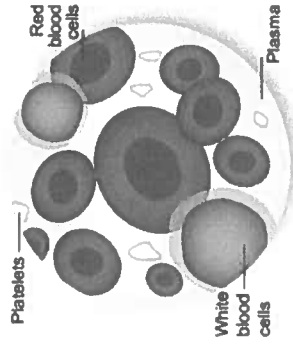

### Box 10 - Transport in plants – Xylem, Phloem and Transpiration

Xylem cells transport water and minerals from the roots to the leaves.

Phloem cells transport sugars around the plant from the leaves to the roots and flowers.

Transpiration is the loss of water from a plant by evaporation.

The rate of transpiration is affected by the temperature.

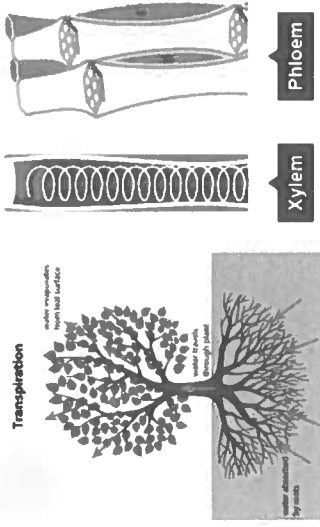

### Box 11 - Transport in plants – Minerals

Plants need minerals from the soil for healthy growth. Nitrates and magnesium are examples of minerals.

Nitrates are needed to make proteins. A plant that is deficient in nitrates has stunted growth and yellow leaves.

Magnesium is needed for making chlorophyll. A plant deficient in magnesium has yellow leaves. Fertilisers contain minerals and can be added to the soil to improve the growth of crops and plants.

### Box 8 - The Circulatory System- Blood vessels

Arteries are blood vessels that carry blood away from the heart under high pressure.

Capillaries are tiny blood vessels with walls that are one cell thick. Substances such as glucose, oxygen can move out of capillaries into cells. Carbon dioxide can move into capillaries from cells.

Veins are blood vessels that carry blood to the heart under low pressure.

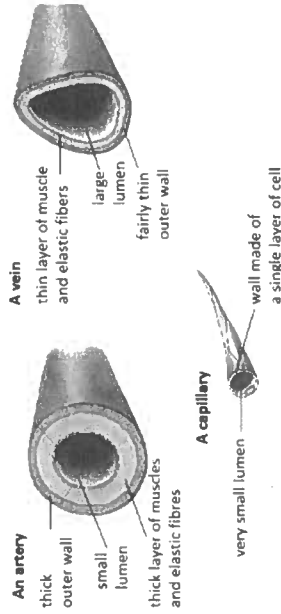

## Year 8 - Chemistry Knowledge Organiser

### Materials and their properties

#### Box 1 - The Structure of the Atom

- All matter is made from atoms. Atoms are very small.
- The central part of the atom is known as the nucleus. The nucleus is tiny in comparison to the size of the atom.
- An atom is made up of three subatomic particles: **protons, neutrons and electrons**.
- Protons and neutrons are found in the **nucleus**
- Electrons are found orbiting the nucleus in energy levels (also known as *shells*).
- The mass and charges of the subatomic particles is shown below:

	Mass	Charge
Proton	1	+1
Neutron	1	0
Electron	0	-1

- Atoms have **no overall charge** because they have the same number of positive protons as negative electrons.

#### Box 3 - Electron Configuration/Electronic Structure

Each shell has a maximum number of electrons it can take.

Shell 1: maximum 2 electrons; Shell 2: maximum 8 electrons; Shell 3: maximum 8 electrons

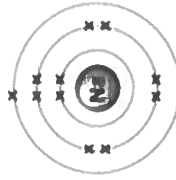

23	<b>Na</b>
	sodium
11	

11 electrons

The electronic configuration of Sodium (Na) can also be written like this: 2,8,1. This shows there is 2 electrons in the 1st shell, 8 electrons in the second shell and 1 electron in the 3rd shell.

- The period number is an element's row in the periodic table. It indicates the number of electron shells an element has.
- The group number is the column an element is in in the periodic table. It indicates how many electrons an element has in its outer shell. All shells inside the outer shell are full.

Key Terms	Definitions
nucleus	The centre of an atom; it is made of protons and neutrons.
nanometre	A unit of measurement: $1 \times 10^{-9} \text{m}$
proton	A subatomic particle found in the nucleus, it has an electric charge of +1 and a relative mass of 1.
electron	A subatomic particle found in the shells of an atom, it has an electric charge of -1 and a negligible mass
subatomic	Describes particles smaller than an atom (protons, neutrons, electrons)
neutron	A subatomic particle found in the nucleus of an atom, it has a charge of 0 and a mass of 1
Physical property	A characteristic or feature of a substance that can be measured (e.g. melting point, boiling point, density, colour, conduction of heat/electricity)

#### Box 2 - Atomic Number and Mass Number

**Mass number:** This is the total protons + neutrons

**Atomic number:** This is the number of protons, which is equal to the number of electrons

23	←
<b>Na</b>	
sodium	
11	←

Therefore sodium has 11 protons, 11 electrons and  $23 - 11 = 12$  neutrons

#### Box 4 Electron Configuration/Electronic Structure

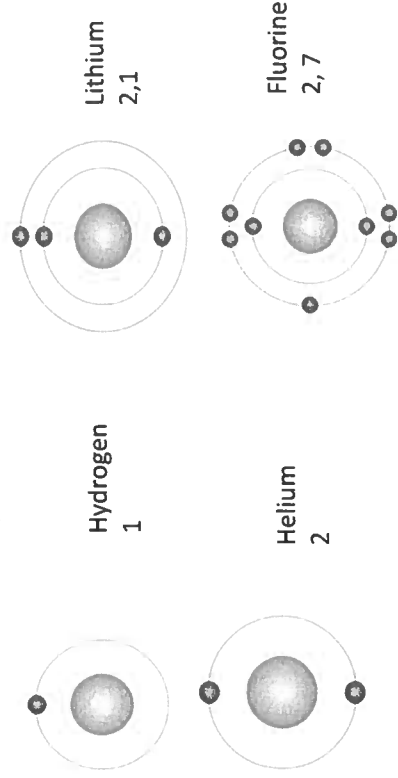

# Year 8 - Chemistry Knowledge Organiser

## Materials and their Properties

### Box 5 – Metals Properties and Metallic Bonding

Metals form giant structures. The outer electrons are called delocalised electrons.

These electrons are free to move and mean that metals are good conductors of electricity and heat. Metallic bonds hold the metal structure together. The bonds are forces of attraction between the negative electrons and the positive metal ions.

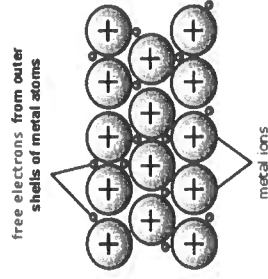

### Box 6 - Alloys

Alloys are mixtures of different **metals or metals and carbon**. Examples of alloys include brass (copper and zinc) and steel (iron and carbon).

Pure metals are soft because the layers of metal atoms/ions can slide over each other.

Metals are alloyed because the different atoms are different sizes, so the layers get disrupted and hence the layers cannot slide.

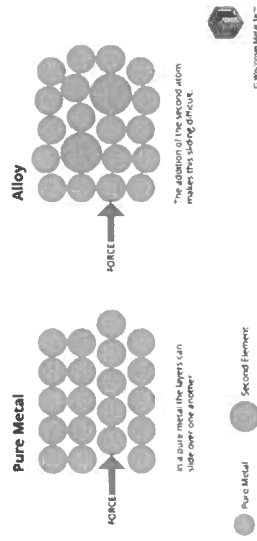

Stainless steel is a mixture of iron and chromium. It's physical properties include that it is hard and does not rust, making it useful for making cutlery. Alloys of aluminium are used to make the bodies of aircraft. The body is hard and low density.

### Box 7 - Composites

Composites are materials made from 2 different materials where one is embedded into the other.

A composite has properties of both materials and are stronger and more durable than the individual materials.

Bone is a natural composite. Concrete, Fibreglass and carbon fibre are man-made composites

### Key Terms

metallic bonding

alloy

delocalised electron

Physical Property

malleable

Ceramic

Composite

Polymer

### Definitions

A type of bonding which occurs only in metals

A mixture of 2 or elements, one of which is a metal (the other element may be metal or non metal)

An electron that is free, not part of an atom

A feature/characteristic of a material or substance – e.g. conducts electricity, hard, strong.

The ability of a material to be hammered/pressed into shape.

Non-metallic solid that is hard, durable and brittle.

Substance made from 2 different materials where the properties of both materials are gained.

Long chain molecules made up from repeating units called monomers.

### Box 8 - Ceramics

Ceramics are non-metallic crystalline solids, for example porcelain, brick. They are made by the action of heating and cooling.

Physical properties - They are hard, durable, brittle, have high melting points and are non-toxic and unreactive.

Ceramics are used for plates, bowls etc because they are durable, non-toxic and unreactive.

Ceramics are used in dentistry because they are hard, durable, non-toxic and unreactive.

### Box 9 - Polymers

Polymers are long chain molecules made up from repeating units called monomers.

Natural polymers include DNA and starch.

Synthetic (man-made) polymers include polythene and polystyrene. These are called plastics and are often made from crude oil.

Polymers can be designed with useful physical properties.

Many synthetic polymers are non-biodegradable (they don't rot away). This means they end in land fill or polluting oceans.

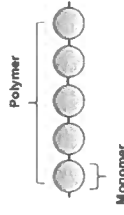

## Year 8 Physics Knowledge Organiser: Electricity

### Box 1 – Series and parallel circuits

- Electrical circuits are made of metal wires with components (see Box 3) that perform a function.
- The metal in the wire is a conductor, so the electric current can pass through the wire – it is conducted.

**Series circuits** are closed circuits where the current can only flow along one route.

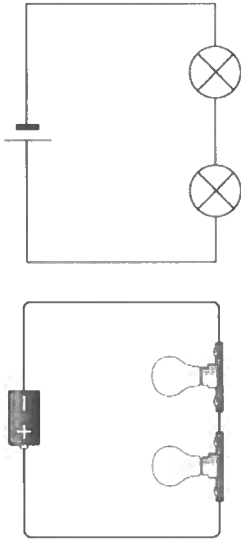

**Parallel circuits** are closed circuits with more than one route (also called branches) that the current can take.

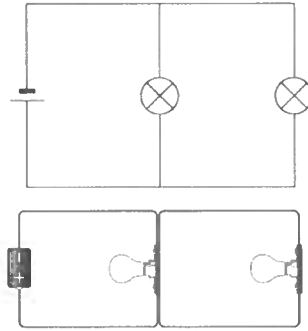

### Box 2 – Describing Circuits Bread van analogy

*Analogy – A story used as an explanation*

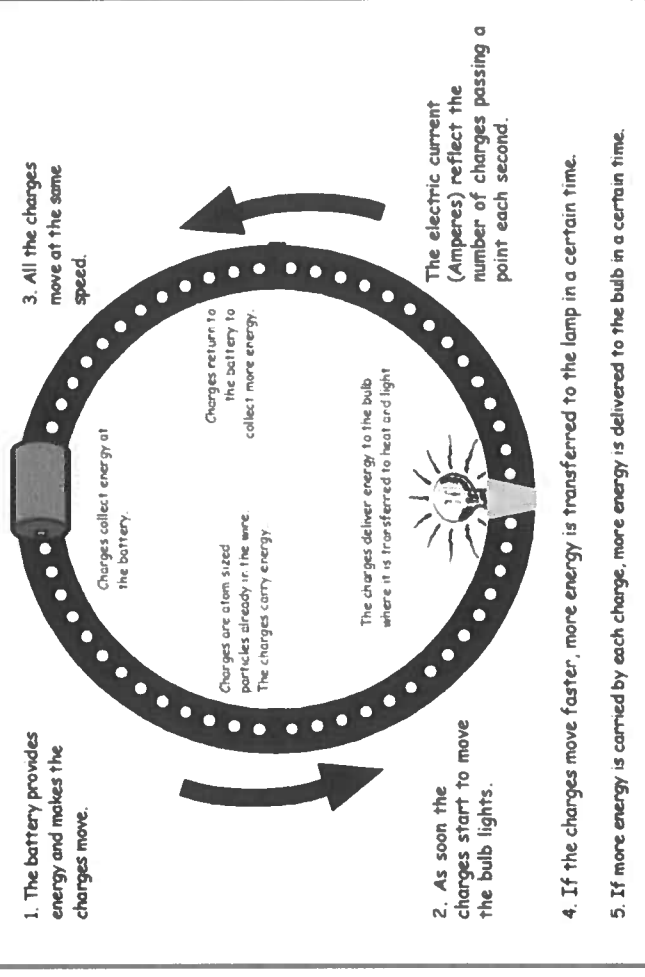
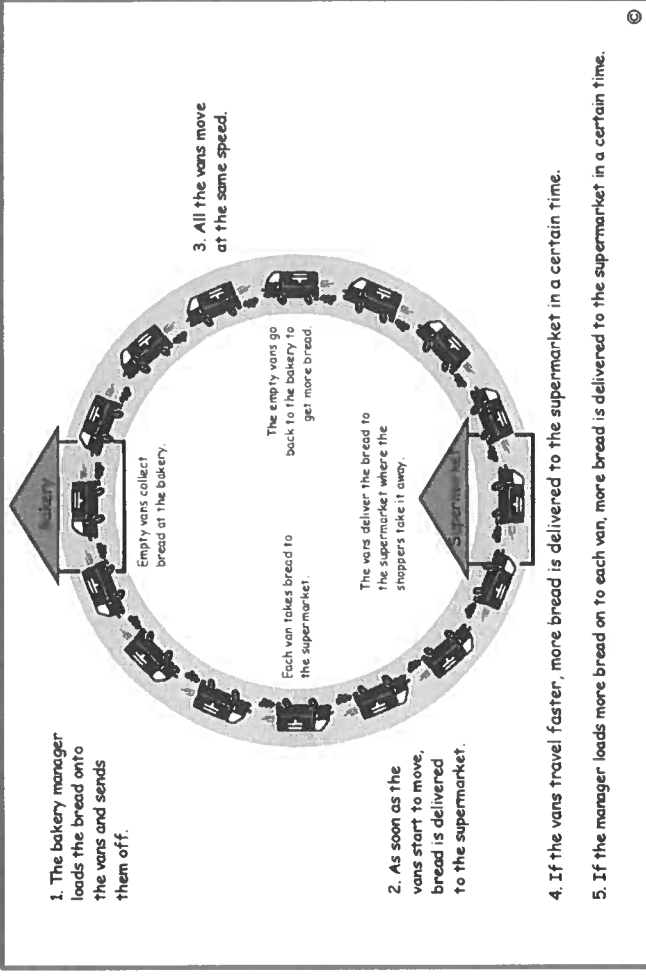

Key term	Definition	Analogy
Charge	The particles that carry energy in an electrical circuit, often electrons	Van
Energy	Electrical energy carried by charges	Loaves of bread
Current	Rate of flow of charge	Speed of vans
Potential difference	The energy per unit of charge	Number of loaves of bread in each van
Resistance	Opposes the current (the more resistance, the lower the current)	Reduces the speed of the vans

## Year 8 Physics Knowledge Organiser: Electricity

Key term	Definition
Electrical conductor	A material with a low resistance that allows charge to flow.
Electrical insulator	A material with a high resistance that does not allow charge to flow.
Series circuit	Circuit with a single loop.
Parallel circuit	Circuit with two or more loops.

Equation	Meanings of terms in equation
$V = IR$	<i>Potential difference = Current x Resistance</i> (Volts, V) (Amps, A) (Ohms, $\Omega$ )

### Box 4 – Using parallel circuits

- Lighting circuits in houses use parallel circuits to make sure all the bulbs in the house are bright and stay the same brightness regardless of how many bulbs are switched on at any one time.
- A parallel circuit also means that if one bulb breaks, the others remain lit.
- Car headlights are also wired in parallel for the same reasons.

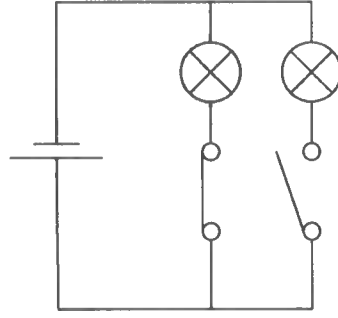

### Box 3 – Circuit symbols

The parts that go into circuits are called components. They are shown in diagrams with symbols, as shown:

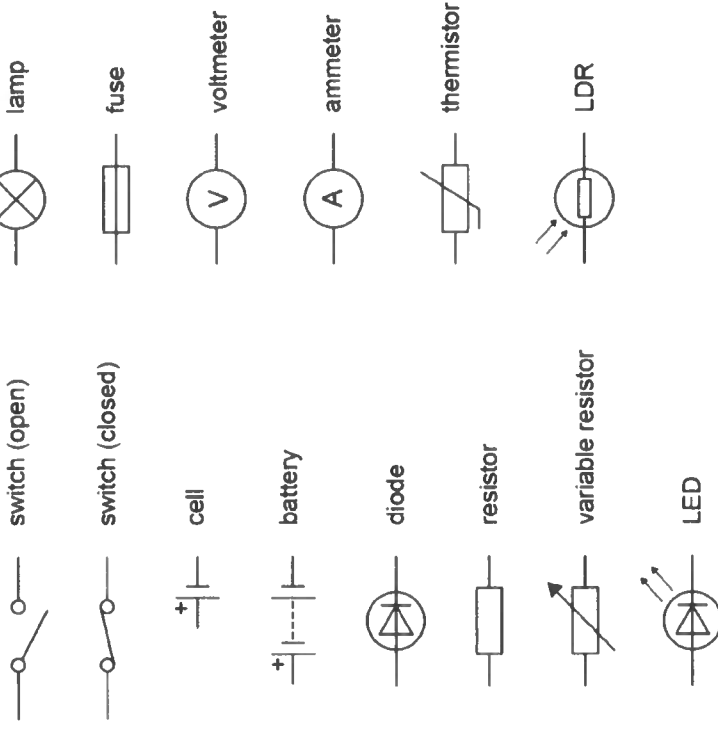

### Box 5 – Kirchoff's current law

Current flowing into a junction in a parallel circuit must be equal to current flowing out of it.

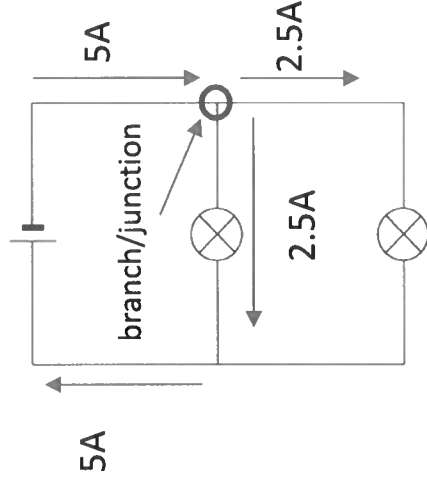

### Box 6 – Kirchoff's potential difference law

The sum of the potential differences in a series circuit is equal to the cell potential difference.

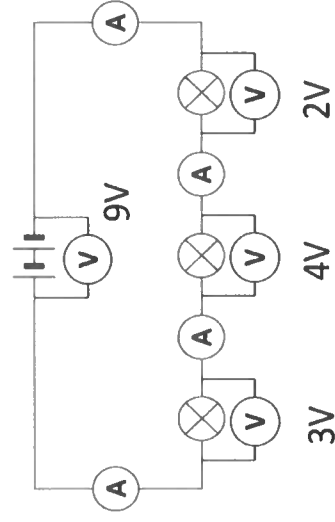

Potential difference of cell = 9V  
 $3 + 4 + 2 = 9$

## Year 8 Chemistry Knowledge Organiser

### Energy Changes and Rate of Reaction

#### **Box 1 – Energy Changes: Exothermic and endothermic reactions**

##### **Exothermic reactions**

- These are reactions that **release/give out energy** to the surroundings. This is usually in the form of heat.
- They cause the **temperature to increase**.
- The **reactants have more energy** in their energy stores **than the products**. (see reaction profile)

##### **Endothermic reaction:**

- These are reactions that **take in energy** from the surroundings.
- They cause the **temperature to decrease**.
- The **reactants have less energy** in their energy stores **than the products**. (see reaction profile)

The diagrams below are called reaction profiles.

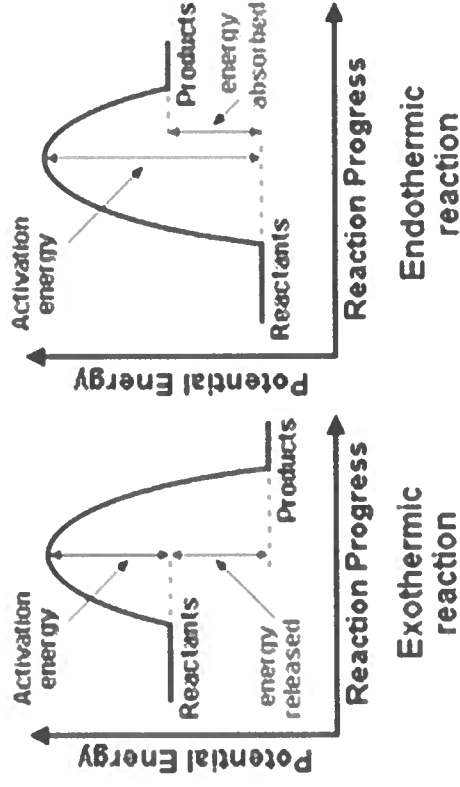

#### **Box 2 – Rate of reaction**

The rate of a reaction is a measure of how quickly a reaction is occurring. Rate = Amount of substance ÷ time  
 The rate of a reaction can be measured by how quickly a reactant is used up or by how quickly a product is made.

Key Terms	Definitions
Exothermic	Reaction that releases energy to the surroundings
Endothermic	Reaction that takes in energy from the surroundings
Energy profile diagram	Graph that shows energy changes in reactions
Rate of reaction	How fast a chemical reaction occurs
Collision theory	The idea that successful collisions are needed between reactant particles if a chemical reaction is to occur.
Activation energy	The minimum amount of energy needed in a collision for a reaction to occur
Catalyst	A chemical that speeds up a reaction without being used up during the reaction
Concentration	The amount of a chemical dissolved in a certain volume of water.

#### **Box 3 – Collision theory**

**A chemical reaction can only occur if the reactant particles collide successfully. To collide successfully they must collide with activation energy.**

Activation energy the minimum amount of energy needed in a collision for a reaction to occur

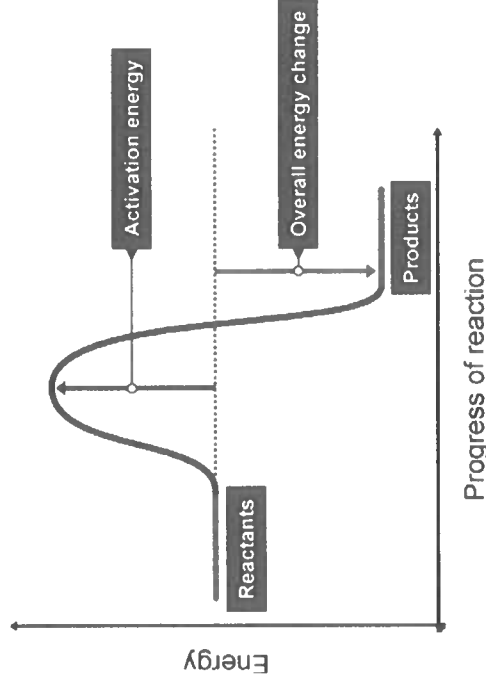

## Year 8 Chemistry Knowledge Organiser

### Energy Changes and Rate of Reaction

#### **Box 4 – Factors that affect the rate of a reaction**

All factors that increase the rate of reaction will increase the frequency of successful collisions between the reactants.

The **rate of a chemical reaction** is affected by:

- **Temperature** – The higher the temperature the faster the rate of reaction, because the particles gain energy, move faster and therefore collide more frequently and with more energy.
- **Concentration** – The higher the concentration of a reactant that is in solution, the faster the rate of reaction. When there are more particles in a set volume, there is a higher frequency of collisions.
- **The pressure of a gas** – The higher the pressure of a gas, the faster the rate of reaction.
- **The surface area of a solid** – Powdered solids react more quickly than lumps of a solid. This is because the powdered solid has a larger surface area over which collisions can occur, therefore there is a higher frequency of collisions.
- **Adding a catalyst** – See Box 5

#### **Box 5 – Explaining concentration**

The amount of a substance dissolved in a certain volume of water.

The higher the concentration, the more particles of the substance there are in a certain volume of water.

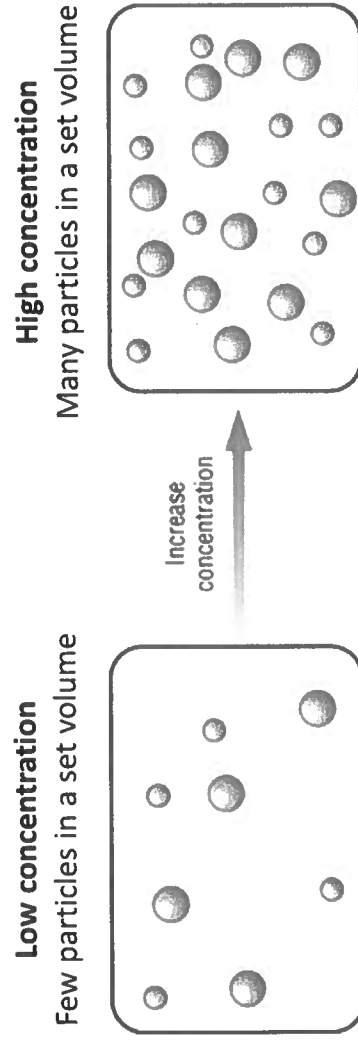

#### **Box 6 – Catalysts**

A catalyst is a chemical that speeds up a reaction without being used up during the reaction.

It does this by providing an alternative reaction pathway with a lower activation energy.

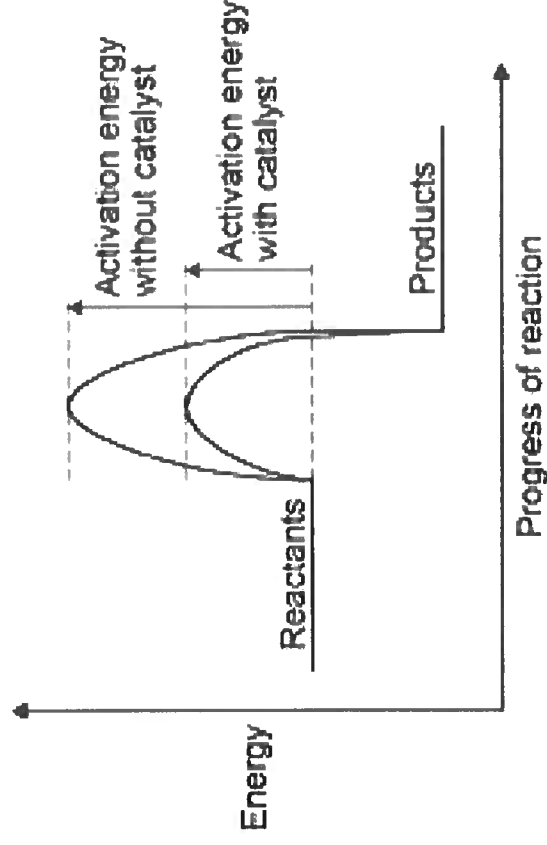

## Year 8 Chemistry Knowledge Organiser – Reactivity

### Box 1 - Metals and Non-Metals

- Metals are found on the left hand side of the periodic table
- When metals react, they lose electrons to form positive ions.

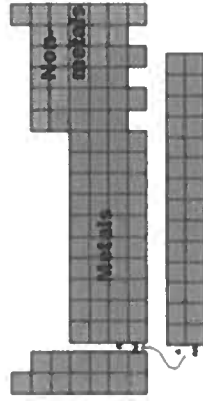

- Properties of metals are: high density, high melting point and good conductors of heat and electricity.
- Only three metals are magnetic (iron, cobalt and nickel).
- Metals react with oxygen to make metal oxides e.g.  
Magnesium + Oxygen → Magnesium Oxide

### Box 2 - Metals and Acids

- Acids react with most metals, producing a salt and hydrogen gas. This is the general word equation for the reaction is:  
**metal + acid → salt + hydrogen**
- The salt produced depends upon the metal and the acid.  
**zinc + sulfuric acid → zinc sulfate + hydrogen**
- To test for hydrogen gas we use the 'squeaky pop' test. This means that hydrogen burns and makes a squeaky pop sound when a lit splint is added.

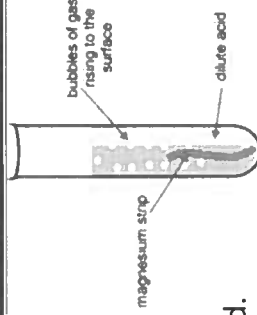

### Box 3 - Corrosion and Rusting

- Corrosion** is where a metal reacts with substances in its environment.
- When iron corrodes we say that it **rusts**. Water and oxygen are required for rusting.
- The equation for rusting is:  
**Iron + Oxygen + Water → Hydrated iron oxide**
- Corrosion can be prevented by coating the metal with paint or oil. Sacrificial protection can also be used. This is where the metal is coated with a more reactive metal (e.g. coating iron with zinc).

### Box 4 - The Reactivity Series

- Elements are ordered by their reactivity in a series called the **reactivity series**.
- Observations of the way that these elements react with water, acids and steam enable us to put them into this series.

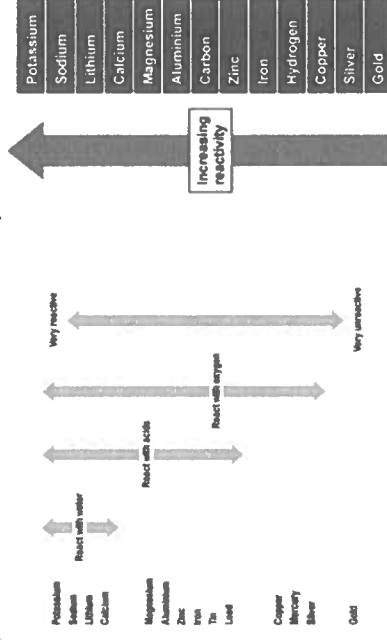

### Box 5 - Displacement reactions

- In a displacement reaction a more reactive metal replaces a less reactive metal in a compound.
- Displacement reactions are **exothermic**.
- The larger the difference in reactivity the greater the temperature rise.
- The example below shows the following reaction  
**Copper sulfate + Magnesium → Magnesium sulfate + Copper**

### Box 6 - Extraction of Metals

- Most metals need to be extracted from their ore so that we can use them.
- A metal ore is a metal compound found in rock, that contains enough metal that it is **economical** to extract it.
- Metals which are less reactive than carbon are extracted from their ore using **reduction**. This is an example of a displacement reaction  
**Example: Iron Oxide + Carbon → Iron + Carbon Dioxide**
- Metals more reactive than carbon are extracted from their ore using **electrolysis**.
- Electrolysis is expensive as it requires a lot of energy.

# Y8 History Knowledge Organiser: The Industrial Revolution

## 1.1 The Industrial Revolution

### Britain underwent a dramatic transformation between 1750 and 1850

#### PRE-1750 An Agricultural Society

- Before 1750, Britain was a largely agricultural society
- Most people lived in the countryside and grew their own food
- The threat of famine kept the population low

#### POST-1750 An Industrial Society

- The process of industrialisation transformed Britain
- Most people now worked in factories and bought food with their wages
- The population expanded as towns and cities grew

Why was there an industrial revolution in Britain in the 18<sup>th</sup> Century?

Natural resources such as coal provided new forms of energy

New technology and machinery increased production

Slavery and empire provided wealth to stimulate industry

## 1.2 The Traditional View

*The traditional pessimistic interpretation of the industrial life is based on sources written from a middle class point of view for a particular purpose and audience*

### Arnold Toynbee

- The 19<sup>th</sup> Century historian Arnold Toynbee argued that the Industrial Revolution was a 'darker period' in history that was 'disastrous and terrible' for ordinary people
- He based his conclusions on sources written by middle-class individuals such as:

### Francis Trollope's novel

- Trollope's novel *Factory Boy* describes the miserable lives of child workers
- The purpose of her novel was to support the growing movement for improved working conditions

### Michael Sadler's interviews

- Michael Sadler interviewed child workers and created a report to support a new law to improve factory work
- Sadler sometimes used leading questions to get the evidence he needed

## 1.3 Emma Griffin

*The historian Emma Griffin has used the autobiographies of ordinary people to construct a different interpretation*

### Griffin's sources

- Emma Griffin looked at 350 autobiographies and memoirs of working people
- These sources provided evidence for a different interpretation of life in industrial Britain

### Griffin's interpretation of life in industrial Britain

- Griffin argues that the Industrial Revolution presented new and exciting opportunities for working class men, even if they lived through hardships
- The autobiographies clearly show that family incomes increased
- However, working class women and children did not share in these advantages

### Problems with Griffin's sources

- Very few women wrote autobiographies, making it hard to find evidence about their lives
- Autobiographers did not want to spend time discussing the difficult times in their life, preferring to focus on positive experiences

## VOCABULARY

<b>Agricultural</b>	Related to farms and farming
<b>Autobiography</b>	A book written about the authors own life
<b>Factories</b>	Large buildings where goods are manufactured by workers and machines
<b>Famine</b>	A period in which there is not enough food
<b>Glasgow</b>	A large industrial city in Scotland
<b>Income</b>	The amount of money you earn
<b>Industrial</b>	An adjective that describes a place or a time when most people worked in factories
<b>Industrialisation</b>	The process of becoming industrial
<b>Justify</b>	To prove something was right
<b>Leading questions</b>	Questions that lead the respondent to give particular answers
<b>Memoir</b>	A type of autobiography
<b>Novel</b>	A fiction book
<b>Poverty</b>	The state of being very poor
<b>Progress</b>	Development towards a more advanced time / state
<b>Purpose</b>	The reason why something is made
<b>Sanitation</b>	Hygiene / Cleanliness
<b>Slums</b>	Poor quality housing
<b>Wages</b>	Money earned from working
<b>Working class</b>	People who work for wages, usually the poorest people in society

# Y8 History Knowledge Organiser: The Development of Democracy

## 1.1 Political power in Britain before 1750

Parliament became increasingly powerful during the Early Modern period, although the franchise was very limited

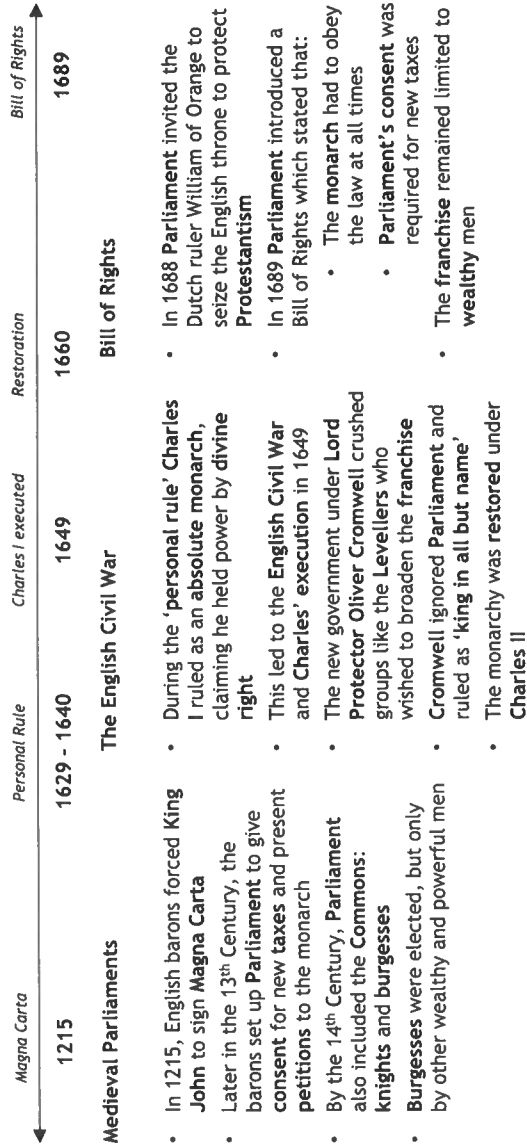

## 1.3 Peterloo

The protests for democratic reform in the early 19<sup>th</sup> Century - and the brutal response from the authorities - reveals the corrupt and repressive nature of British government

### The Peterloo Massacre

- On 16<sup>th</sup> August 1819, over 60,000 people gathered in St Peter's Field in Manchester to protest for democratic reform and listen to radical speakers such as Henry Hunt
- Fearing an uprising, the authorities demanded that the crowd leave and the speakers be arrested
- When the crowd linked arms to protect the speakers, the mounted Manchester Yeomanry charged
- 18 protestors were killed and over 700 injured

### Why did so many people join the protest?

- In 1819 only 5% of the adult population could vote, excluding all women and huge industrial towns such as Manchester
- 'Rotten boroughs' and public elections led to corruption
- Trade unions were illegal
- These realities clashed with the ideas of the age of revolution

### Why did the authorities respond brutally?

- The authorities feared a revolution similar to the one in France and believed it could only be stopped by brutal repression
- The Manchester Yeomanry were made up of wealthy local businessmen who saw democratic reform as a threat to their power

## 1.2 The Age of Revolution

Revolutions in America, France, and Haiti increased the pressure for democratic reform

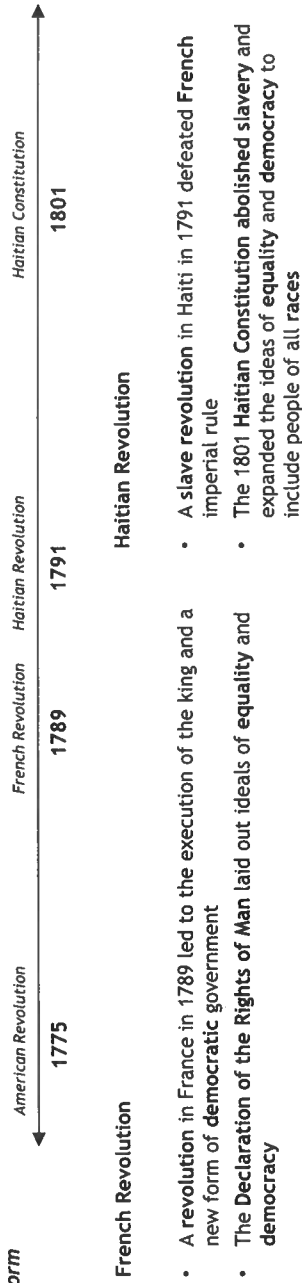

# Y8 History Knowledge Organiser: The Development of Democracy

## 2.2 Women's Suffrage

Although the franchise had expanded by the end of the 19th Century, women were still excluded from political life

Under pressure from groups such as the Chartists, Parliament passed a series of acts that reformed British democracy

## 2.1 Chartism and 19th Century Reform

### 1832

- The Great Reform Act
- Abolished the rotten boroughs and gave MPs to growing industrial towns like Manchester
  - Expanded the franchise to include all men with land worth over £10 a year, about 6% of the population

### The Chartists

- The Chartist movement grew out of anger at the failure of the Great Reform Act to give the vote to the working class
- They presented petitions to Parliament with millions of signatures, demanding their Six Points:
  - Votes for all men
  - Elections every year
  - Equal representation for all regions
  - Secret ballots
  - All men can be MPs
  - Pay for MPs
- The Chartists lost power after 1848, yet their influence can be seen in later 19th Century reforms

### Parliamentary Reform

### 1867

- The 1867 Reform Act
- Gave more MPs to industrial areas in the North
  - Increased the electorate to 15% of the population by giving the vote to men who paid £10 or more in rent

### 1872

- The 1872 Ballot Act
- Introduce the secret ballot, allowing voters to cast their votes in secret

### 1884

- The 1884 Reform Acts
- Set up a commission to ensure MPs were elected by an equal number of votes
  - Increased the electorate to 30% of the population

Rights of Women?

- In 1792, Mary Wollstonecraft published *A Vindication of the Rights of Women*
- She argued that women were human beings who deserved the same rights as men

However, 19th Century Britain was a highly patriarchal society:

- Women were legally the property of their husbands and could be physically abused
- Women were not allowed to own property
- Even by 1900, women could not vote

Opponents of women's suffrage employed a variety of false arguments

Some women still played a significant role in public life

- Separate spheres:** women belonged in the private, domestic sphere, not the public male sphere of politics
  - Loss of femininity:** entering the world of politics might make women less feminine
  - Biology:** women were hysterical and wouldn't be able to cope with the pressure of political decisions
- Women could vote in local elections after 1869 and played a role in local government
  - There were women's suffrage societies across the country who held meetings and submitted petitions to Parliament demanding votes for women
  - Women were also active in the trade union movement, for example winning improved working conditions during the **1888 Match Girls' Strike**

## VOCABULARY

**Absolute Monarch** A monarch with complete power

**Act** A new law

**Authorities** The local / national government

**Ballot** A vote

**Burgess** The representative of a town / city

**Commission** A government agency

**Democracy** Government based on the will of all the people

**Divine Right** King's authority based on God, not the people

**Domestic** Related to the home, including cooking / children

**Electorate** The number of people who are allowed to vote

**Equality** An organised vote for political leaders

**Femininity** Being treated/seen as the same as other people

**Franchise** Stereotypically like a woman

**Haiti** The right to vote in elections

A French Caribbean colony

**Hysterical** Highly emotional / out of control

**Local elections** Votes for local councils

**MPs** Members of Parliament, elected

**Parliament** The elected part of the UK government

**Patriarchal** Ruled by men

**Petition** A written appeal or request given to Parliament

**Public elections** An election where voters have to vote publicly

**Reform** A slower and gradual change

**Repression** The crushing of protest by force

**Revolution** A sudden often violent change

**Rotten Borough** A tiny place that still elected MPs

**Secret Ballot** An election where voters vote in secret

**Suffrage** The right to vote in elections

**Trade union** Organisations of workers to protect their rights

**Yeomanry** A military unit made up of local businessmen

# Y8 History Knowledge Organiser: India and 1857

## 1.3 Causes of rebellion in 1857

### 1.1 The Mughal Empire

From the 16<sup>th</sup> Century India was ruled by the powerful and wealthy Mughal Empire

- The Mughal Empire was founded by Emperor Babur in 1526
- The Empire contained over 150 million people and controlled 25% of global wealth

Mughal Emperors used their wealth...

- ...to build a capital city at Delhi
- ...to built great monuments such as the Taj Mahal

In the early 18<sup>th</sup> Century, the Empire declined as other Indian states began to challenge Mughal control.

The Mughal Empire was home to many religions. The largest were:



Although they were Muslims, the Mughal emperors were tolerant of other religions.

### 1.2 The East India Company

By 1857, large parts of India were ruled by a British trading company: the East India Company

Trading Posts

The East India Company was set up by British merchants in 1600 to trade for jewels, tea, and cotton.

The East India Company set up trading posts on the coast of India.

Sepoys

The Company recruited sepoys - Indians mercenaries - to protect their trading posts

The sepoys were led by British officers. Robert Clive led the Company's Bengal Army

Company Rule

In 1757 Clive defeated the Nawab of Bengal in the Battle of Plassey.

This began the period of Company Rule: the East India Company was not just trading but actually *ruiling* large parts of India.

Clive became the Governor of Bengal. He added to his income by collecting taxes and taking loot.

Annexation

- In the 19<sup>th</sup> Century, the East India Company continued to expand its territory
- The Company annexed Indian provinces such as the Punjab (1848) and Awadh (1856)

Company Rule

- Many Indians felt that the Company was asking them to pay too much tax
- During the 1770 Bengal Famine, 10 million Indians died. This proved to many Indians that the East India Company was more interested in profit than ruling India well.
- Hindus and Muslims were worried that British missionaries were trying to stop traditional religious practices, such as Sati

Enfield Rifles

- In 1857 the East India Company's armies issued the sepoys with new Enfield Rifles
- To load the new rifles, sepoys had to bite a cartridge greased with pig and cow fat
- Hindu sepoys considered cows to be holy animals and refused to use the new rifles; Muslim sepoys also refused as the Qu'ran forbid them from eating pork
- When East India Company commanders threatened to punish any sepoys who would not use the new rifles, the sepoys mutinied

# Y8 History Knowledge Organiser: India and 1857

## 2.1 Events of the rebellion

Although the rebellion began as a sepoy mutiny, it quickly spread to other parts of the Indian population, though some Indians remained loyal

### Mutiny at Meerut

- In April 1857, sepoys in Meerut were arrested for refusing to fire the Enfield rifle
- Other sepoys in Meerut mutinied and marched towards Delhi, the old Mughal capital
- The rebels were joined by Indian civilians
- Within a few months, the rebels controlled northern India and chose a descendant of the Mughal emperors as their leader

### India Divided

- During 1857, the Company lost control of most of northern and central India
- However, some areas - such as Madras - did not experience mutinies or rebellions
- Sikhs from the province of Punjab remained loyal to the Company because they did not trust the mutinous sepoys who were mainly Hindus and Muslims

### The Rani of Jhansi

- The Rani of Jhansi, a province in northern India, initially supported the Company and fought off attacks by mutinous sepoys who wanted to seize her province
- However, when British forces tried to seize Jhansi for themselves in 1858, she fought for the independence of her province before being killed in battle

### End of the Rebellion

- By 1858, fresh soldiers arriving from Britain and Punjabi Sikhs had crushed the rebels
- The British executed anyone who they suspected of supporting the rebellion
- After the rebellion, the British government ended Company Rule and ran India itself

## 2.2 Interpreting 1857

In the years after 1857, people in Britain and India gave different names to the events of 1857

### THE SEPOY MUTINY

British historians in the 19<sup>th</sup> Century called the rebellion the **sepoy mutiny** to suggest that only a small number of sepoys had rebelled

Why did historians use this name?

- After 1858, India was ruled directly from London during the **British Raj**

- Queen Victoria was named **Empress** and 1,000 British civil servants ruled over 200 million Indians

- British historians suggested that the rebellion was just a minor disagreement with a small number of sepoys to **justify** continued British rule in India
- **Nationalists** such as Savarkar suggested that 1857 was a war of independence because they wanted to **inspire** Indians to rebel against Britain again

### INDIAN WAR OF INDEPENDENCE

The Indian nationalist leader **Veer Savarkar** called the rebellion an **Indian War of Independence** to suggest that the rebels wanted freedom from British rule

- In the early 20<sup>th</sup> Century, a nationalist movement began to protest for **Indian independence**

- From 1915, **Gandhi** led peaceful protests against the **British Raj**

## VOCABULARY

**Annex** To add (a territory to an empire)

**Annexation** The process of adding a territory to an empire

**British Raj** The period of direct British rule of India from 1858 to 1947

**Cartridge** A gunpowder container

**Civilian** A person not in the army

**Company Rule** The period of the East India Company ruling parts of India from 1757 to 1857

**Famine** A period of hunger and starvation caused by a lack of food

**Independence** Being free from an empire

**Inspire** Make someone want to do something

**Justify** Make something seem right or reasonable

**Mercenaries** Soldiers who fight for money

**Missionaries** European Christians who tried to convert people to Christianity

**Mutiny** A rebellion by soldiers or sailors against their commanders

**Mutinous** An adjective describing soldiers or sailors who had rebelled against their commanders

**Nationalist** Someone who supports the independence of a colony from an empire

**Peaceful protest** A protest that uses non-violent methods

**Punjab Province** A province in northwest India

**Rani** A Hindu queen

**Sati** Traditional Hindu practice of burning a widow with her dead husband

**Sepoy** An India soldier who was paid to fight for the East India Company

**Tolerant** Being happy to allow religious beliefs different to your own

**Trading Post** A coastal settlement to allow ships to land to import and export goods

### Geography Topic 3 – Is the geography of Russia a curse or a benefit?

<p><b>KP11: Key Words</b></p> <ol style="list-style-type: none"> <li><b>Abiotic:</b> Non-living</li> <li><b>Adaptation:</b> the process of change by which an animal becomes better suited to its environment.</li> <li><b>Abundance:</b> a lot of</li> <li><b>Arctic circle:</b> One of the two polar circles, and the most northerly of the five major circles of latitude as shown on maps of Earth</li> <li><b>Biomes:</b> a large naturally occurring community of flora (plants) and fauna (animals) occupying (living in) a major habitat</li> <li><b>Biotic:</b> Living</li> <li><b>Choropleth map:</b> a map that presents data using shading or colours</li> <li><b>Climate Graph:</b> A graph that presents data on the temperature and rainfall for a particular area throughout the year.</li> <li><b>Coniferous woodland:</b> Trees that produce cones, and have leaves that do not fall off in the winter.</li> <li><b>Continental climate:</b> A climate that has hot summers, cold winters, and little rainfall, typical of the interior (inside) of a continent.</li> <li><b>Deciduous woodland:</b> Trees that lose their leaves during winter.</li> <li><b>Densely populated:</b> a lot of people per km<sup>2</sup></li> <li><b>Ecosystem:</b> An environment containing a community of interdependent plants and animals (plants and animals that rely on each other).</li> <li><b>Environmental pressure groups:</b> groups of people who share a common interest and try to influence the decisions made by businesses, organisations or governments</li> <li><b>Exclusive economic zone:</b> an area of coastal water and seabed within a certain distance of a country's coastline, to which the country claims exclusive rights for fishing, drilling, and other economic activities.</li> <li><b>Exports:</b> Goods sent to other countries.</li> <li><b>Indigenous:</b> Originating in a place</li> <li><b>Migration:</b> Movement of people</li> <li><b>Peninsular:</b> a piece of land almost surrounded by water or projecting (sticking out) into a body of water.</li> <li><b>Permafrost:</b> a thick subsurface layer of soil (a layer of soil just below the surface) that remains below freezing point throughout the year</li> <li><b>Plain:</b> a landmass (area) that is flat or gently rolling and covers many km</li> <li><b>Population density:</b> the number of individuals divided by the size of the area.</li> <li><b>Precipitation:</b> rainfall</li> <li>Raw Materials: the basic material from which a product is made.</li> <li><b>Resource:</b> a stock or supply of money, materials, staff, and other assets that can be drawn on by a person or organization in order to function effectively.</li> <li><b>Self-sufficient:</b> needing no outside help</li> <li><b>Sparsely populated:</b> Very few people live in an area</li> </ol>	<p><b>KP12: What is an ecosystem?</b></p> <p>An <b>ecosystem</b> is 'an environment containing a community of interdependent plants and animals'.</p> <p>It is made up of 2 parts: Living (<b>biotic</b>) factors and Non-living (<b>abiotic</b>) factors</p> <p>An <b>ecosystem</b> is made up of different parts including...</p> <ul style="list-style-type: none"> <li>• A food chain shows which what eats what or the transfer of energy between different organisms.</li> <li>• A producer is a plant that gets its energy from the sun.</li> <li>• A primary consumer is an organism that eats the producer.</li> <li>• A secondary consumer is an organism that eats the primary consumer.</li> <li>• A decomposer is an organism that eats dead or decaying matter and returns nutrients back to the soil.</li> <li>• A food web is shows all the connections in an ecosystem.</li> </ul> <p><b>KP13: Where is Russia located?</b></p> <p>In the continents of Asia and Europe. Surrounded by 14 countries including Mongolia, Kazakhstan, Ukraine, Belarus, Finland. It is surrounded by the Arctic Ocean and the Pacific Ocean.</p> <p><b>KP14: What is the climate of Russia?</b></p> <p>Most of Russia experiences a <b>continental climate</b> – characterised by two main seasons: long dark cold winters with brief, often warm summers. Precipitation is low throughout the years.</p> <p><b>Climate Graphs</b></p> <p>Climate can be displayed on a graph. A climate graph contains two pieces of information, the <b>precipitation</b> and the temperature of an area. The temperature is shown as a line, and the rain is displayed as bars. The figures are usually calculated as an average over a number of years.</p>	<p><b>KP15: What biomes exist in Russia?</b></p> <p>Most of Russia is dominated by the taiga and tundra <b>biome</b>.</p> <p><b>Taiga Biome:</b></p> <ul style="list-style-type: none"> <li>• Characterised by <b>coniferous</b> forests – consists mainly of pines, spruces and larches.</li> <li>• Largest biome in Russia.</li> <li>• Contains more than 55% of the world's conifers.</li> </ul> <p><b>Adaptations in the taiga biome</b></p> <ul style="list-style-type: none"> <li>• Evergreen, no need to renew leaves during the short growing season</li> <li>• Thick resinous (contains resin) bark acts as protection against the cold winds</li> <li>• Cones protect seeds in winter loss</li> <li>• Long shallow roots for anchorage (a means of securing) against strong winds</li> <li>• Trees have long thin needles which reduce moisture loss</li> </ul> <p><b>Tundra biome:</b></p> <ul style="list-style-type: none"> <li>• Coldest of all the <b>biomes</b>.</li> <li>• The Siberian tundra is located in the north-eastern part of Russia between 60° to 80° North latitude and 70° to 80° East longitude.</li> <li>• Winters are long and summers are short.</li> <li>• Soils form very slowly in these cold conditions – much is frozen as permafrost.</li> </ul> <p><b>Adaptations in the tundra biome:</b></p> <ul style="list-style-type: none"> <li>• Plants of the Siberian tundra grow low to the ground to be protected from the wind and the cold.</li> <li>• Plants group together to keep warm.</li> <li>• Plant roots spread out on the surface to take in water.</li> <li>• They don't grow deep roots because the soil is always freezing and thawing which would break up</li> </ul>
--	--	---

## Geography Topic 3 – is the geography of Russia a curse or a benefit?

<p><b>KP16: How have animals adapted to cold environments?</b></p> <p><b>Adaptation:</b> the process of change by which an animal becomes better suited to its environment.</p> <p>Polar Bear has adapted by:</p> <ul style="list-style-type: none"> <li>• A white appearance - as camouflage from prey on the snow and ice</li> <li>• Thick layers of fat and fur - for insulation against the cold</li> <li>• Large feet - to distribute their load and increase grip on the ice</li> <li>• A greasy coat that sheds water after swimming - to help reduce heat loss</li> <li>• A small surface area to volume ratio - to minimise heat loss</li> </ul> <p>Arctic Hares have adapted by:</p> <ul style="list-style-type: none"> <li>• Arctic hares have a very keen sense of smell that allows them to find food hidden beneath the snow and detect predators before they strike.</li> <li>• It's ability to dig holes beneath the snow to escape the cold wind</li> <li>• During winter, the coats are snow white and provide excellent camouflage, but towards spring, the color changes to blue-gray to match vegetation and local rocks.</li> <li>• The paws of the Arctic hare are padded with the fur to help the animal spread weight while walking on snow and provide insulation from icy surfaces.</li> <li>• The broad paw also provides a better grip on slippery surfaces, especially when running from predators</li> </ul>	<p><b>KP17: Where do people live in Russia?</b></p> <p>Russia is the largest country in the world by area, but it is ranked 9<sup>th</sup> largest worldwide for population.</p> <p><i>How to calculate population density:</i></p> <p><b>Population density</b> is calculated like this:</p> $\frac{\text{Total population}}{\text{Area}}$ <p>The total population of Russia is 144,000,000 people. The area is 17,098,246km<sup>2</sup></p> $\frac{144,000,000}{17,098,246} = 8.4 \text{ people per km}^2$ <p>So in each km<sup>2</sup> in Russia there are 8.4 people.</p> <p>Places that are crowded are called <b>densely populated</b> areas. Places that only have a few people living there are <b>sparsely populated</b> areas.</p> <p><b>Reasons for population density:</b></p> <p>A place is <b>densely populated</b> if:</p> <ul style="list-style-type: none"> <li>• Rich soils for farming</li> <li>• Good communication options such as ports</li> <li>• Temperate weather conditions</li> </ul> <p>A place is <b>sparsely populated</b> if</p> <ul style="list-style-type: none"> <li>• There are difficult landscapes such as mountains or deserts</li> <li>• Harsh climates</li> <li>• Risk of floods or earthquakes</li> </ul> <p>77% of Russia's population live in the European part of the country, west of the Ural Mountains.</p>	<p><b>KP18: How have humans adapted to cold environments?</b></p> <p>Humans have <b>adapted</b> to the following conditions by:</p> <p>Extreme temperatures:</p> <ul style="list-style-type: none"> <li>- People dress warmly and this can make outdoor work very slow and difficult.</li> <li>- Steep roofs – to stop snow from gathering on the roof and risk collapsing in on the house.</li> <li>- Triple glazing – to ensure heat is not lost through the windows</li> <li>- Fuel supply – it is important to keep the houses warm in the extremely low temperatures and make sure you have a supply of fuel in case your house is cut off</li> <li>- Stilts – to stop your house from flooding when the snow melts in the summer</li> <li>- Small windows – these would reduce heat loss</li> <li>- Underground pipes to prevent them from thawing the permafrost and allow easy maintenance.</li> </ul>	<p><b>KP15: Does the geography help or hinder the Russian economy?</b></p> <p><i>The geography of Russia helps the economy because:</i></p> <ul style="list-style-type: none"> <li>• Russia has an <b>abundance</b> of natural resources.</li> <li>• It provides 20% of the world's natural gas and is the world's leading producer of oil.</li> <li>• Russia is <b>self-sufficient</b> in all major industrial raw materials and contains the 8<sup>th</sup> largest crude oil reserves</li> <li>• Russia <b>exports</b> steel and aluminium</li> <li>• 20% of the world's forests lie in Russia, supply the world's timber.</li> </ul> <p><i>The geography of Russia hinders the economy because:</i></p> <ul style="list-style-type: none"> <li>• It is a vast country so transport across the country is a problem (much of the natural resources are in Siberia and the north)</li> <li>• Many of the roads are in poor condition because of the constant maintenance needed due to damage from the extreme cold (-35°C)</li> <li>• Russia depends on railways including the world longest railway line, but this railways line does not extend to the north where many of the resources are.</li> </ul>	<p><b>KP17: Why did Russia plant their flag on the seabed of the North Pole?</b></p> <p>In 2007, Russian explorers carried out scientific research on the ocean floor near the North Pole. Two submarines planted a metre-high titanium Russia flag to claim this land as their own.</p> <p><i>What is the Arctic like?</i></p> <p>The Arctic is a region surrounding the North Pole that consists of the Arctic Ocean, surrounded by land.</p> <p><i>Who owns the Arctic?</i></p> <p>International law states that Arctic countries are allowed an <b>exclusive economic zone (EEZ)</b> of 200 miles bordering their coastline. Countries can apply to the United Nations to extend this zone and 'own' the land but they must have geological data to support the claim that this area of land is part of their continental shelf. If successful, then that country can control all the resources on or under the region of the continental shelf.</p> <p><i>What is the environmental impact?</i></p> <p>Environmental groups such as Greenpeace are concerned about the potential economic damage these economic developments will have on the environment. For example, Arctic oil drilling is high risk. Russia produces 12% of the world's oil but is responsible for 50% of the world's oil spills.</p> <p><i>What is the impact for local people?</i></p> <p>The <b>indigenous</b> population of the Arctic (the Nenets) live in the Yamal Peninsula. The Nenets have always moved seasonally with the reindeer but now their migration routes are affected by oil and gas pipelines.</p>
---	--	--	---	--

## Year 8 – Topic 4 - Year 8 Geography – Where do people live?

### KP1: Key words:

- **Sustainable:** actions that meet the needs of the present without stopping future generations from meeting their own needs.
- **Social sustainability:** a process for creating sustainable successful places that promote wellbeing, by understanding what people need from the places they live and work.
- **The economy:** The state of a country or region in terms of the production and consumption of goods and services and the supply of money.
- **Economic sustainability:** refers to practices that support long-term economic growth.
- **Urban Planning:** Strategies that involve recommending locations for roads, schools and other infrastructure.
- **Unsustainable:** actions that cannot be maintained into the future.
- **Urban greening:** Planting more greenery around a city.
- **Megacity:** Cities with over 10 million people.
- **Population distribution:** The pattern of where people live.
- **CBD:** Central business district where shops, offices and historic buildings are located at the centre of the city.
- **Migration:** movement of people from one place to another
- **Natural increase:** the difference between the number of births and the number of deaths recorded over a period
- **Urban Sprawl:** the rapid expansion of the geographic extent of cities and towns
- **Counter urbanisation:** when large numbers of people move from urban areas into surrounding countryside or rural areas
- **Push Factor:** force people to move from a place e.g., famine
- **Pull Factor:** encourage people to move to a place e.g., jobs
- **Rural Urban Fringe:** the area at the very edge of the city beside the countryside
- **Mega City:** an urban area with a total population of over 10 million

### KP11 – What makes an area sustainable?

For an area to be sustainable it has to include social, economic, political and environmental aspects. For example...

1. It has to be well run
2. It has to have lots of services
3. It has to be positive for the environment
4. It has to be fair for everyone.
5. It has to have a successful economy
6. It has to have well designed and well built homes.
7. It has to be active, inclusive and safe.

### KP12 – How can a city be environmentally sustainable?

Example: Curitiba – located in South East Brazil.

- Rapid population growth caused problems such as
1. Mass unemployment
  2. Traffic congestion
  3. Lack of basic services

How is Curitiba environmentally sustainable now?

1. **Bus Rapid Transit System:** Roads with express lanes for buses, specially designed buses for quick boarding and cheap and uniform ticket prices have helped Curitiba maintain a quick, cheap and low-emission transit system.
2. **Green Space:** Since the 1970s, Curitiba has planted 1.5 million trees and built 28 public parks. To maintain the fields, the city uses sheep rather than mechanical means.
3. **Recycling:** Curitiba recycles around 70 percent of its waste thanks to a programme that allows for the exchange of bus tokens, notebooks and food in return for recycling.
4. **Education:** Curitiba houses the Free University for the Environment, which teaches them about sustainability. Signs and information panels provide citizens with information about the city's green design. Encouraging a culture of pride around sustainability and promoting knowledge helps to maintain the city's greenness

### KP13 – How can a city be socially sustainable?

Example: Gothenburg – located in South Sweden

How is Gothenburg socially sustainable?

1. Gothenburg has plenty of community facilities including health centres and schools.
2. Gothenburg has recreational spaces including Jubilee Park that acts as a gathering point for 15,000 people. It includes a swimming pool, sauna and roller derby area.
3. Gothenburg has tried to improve safety by using large concrete flower beds instead of concrete bollards.
4. Gothenburg is a walkable city with convenient transport, entertainment and public spaces.

### KP14 - How can a city be made economically sustainable?

Example: Stockholm – located in South Sweden

How is Stockholm economically sustainable?

1. **Public Transportation:** Stockholm's efficient public transportation system helps people get to work quickly and reliably. This boosts productivity and saves money.
2. **Modern Facilities:** The city has modern infrastructure, including well-maintained roads, bridges, and communication networks. This supports businesses and economic activities.
3. **Multiple Industries:** Stockholm's economy is not reliant on just one industry. It has a mix of technology companies, finance, manufacturing, and services. This makes the economy more stable and less vulnerable to changes in one sector.
4. **Startups and Tech Companies:** Stockholm is known for its innovation and is home to many successful startups and tech companies like Spotify and Klarna. These companies create jobs and drive economic growth.
5. **High-Quality Education:** Stockholm has excellent schools and universities that provide high-quality education. This ensures that people have the skills needed for good jobs and can contribute to the economy.
6. **Attractive Living Conditions:** Stockholm is a great place to live, with good healthcare, education, and recreational facilities. This attracts talented people and businesses to the city

### KP15 – Is Gloucester a sustainable city?

#### How has Gloucester become unsustainable?

1. **Urban sprawl:** The city has rapidly grown leading to a loss of green space. This has meant a loss of habitats. It has also increased car dependency.
2. **Cars:** An increased reliance on cars has meant more air pollution and traffic congestion
3. **Housing demand:** A growing population has meant that there isn't enough housing for everyone. This has led to an increase in property prices and rent prices. It has made Gloucester increasingly unaffordable.

#### How has Gloucester become sustainable?

1. **Urban greening:** More greenery has been planted around the city. This has improved air quality in some places and improved quality of life.
2. **Segregated cycle lanes:** Cycle lanes in some areas are now separate from the roads, increasing safety and allowing more people to exercise.
3. **Habitats:** Gloucester has created more habitats for species such as the Great Crested Newt population.

## Year 8 – Topic 4 - Year 8 Geography – Where do people live?

### KPI 6: How do cities grow?

There are two main reasons why cities are getting bigger:

1. Rural-urban migration: The movement of people from the countryside into towns and cities.
2. Natural Increase: Where the birth rate is higher than the death rate.

As population grows, megacities are created.

Geographers create models to show how land is 'typically' used within cities.

The Burgess Model shows that in cities the most expensive land is in the centre and then as land use changes to the outskirts of the city it becomes less dense.

1. **CBD** – core of the city. Contains shops, offices and entertainment. Few residential. High buildings.
2. **Inner City** – Mixed land use of small industries, small houses and offices.
3. **Inner Suburbs** – Housing dates 80 – 100 yrs. Terraced houses with back yards.
4. **Outer Suburbs** – Semi-detached houses 1930+ Council houses. Shopping parades. Out-of-town shops.
5. **Rural/urban fringe** – Green belt around urban areas. Beyond it, small towns and villages. High cost housing.

There are limitations to this model such as:

1. Outdated and was created before car ownership was common.
2. Development of UK cities is different and not every city has developed in the same way.
3. Over time, cities have evolved and many of the previously suggested land use in the different sectors has now changed.

### KPI 7: Is Tokyo manageable as a megacity?

What has bought people to Tokyo?

1. Few services in rural areas.
2. Better transport links in urban areas.
3. Improved living conditions in urban areas.
4. More entertainment opportunities in urban areas
5. Lack of job opportunities in rural areas.

These can be sorted into push and pull factors.

1. Push factors: Negative reasons to leave their homes and migrate.
2. Pull factors: Positive reasons which draw people to they places they migrate to.

What are the opportunities in Tokyo due to the growing population?

1. Tokyo is home to many international companies and businesses, offering a wide range of job opportunities in sectors like finance, technology, and manufacturing.
2. Tokyo is a major global city, meaning it has strong connections with other countries, which brings in diverse cultures, foods, and languages.
3. There are many prestigious universities and schools in Tokyo, providing excellent education and learning
4. Tokyo has one of the best public transportation systems in the world, including subways, buses, and trains that make it easy to travel around the city.

What are the challenges in Tokyo due to the growing population?

1. There is a major strain on housing with more than 20,000 people per km<sup>2</sup>.
2. There is increasing demand on Tokyo's water supply.
3. Despite its wealth, there are significant differences in income and living conditions among Tokyo's residents. Some people live in luxury, while others struggle to afford basic necessities.
4. The city has issues with air pollution due to traffic and industrial activities.

### KPI 8: Why is counter-urbanization taking place in the UK?

Reasons for increasing urban population can be sorted into two categories:

1. Push Factor is something which is negative about the place you are in that would force you to move away
2. Pull Factor is something positive about a place that may make you want to move there

Examples of push and pull factors include:

- Location
- Crime rates
- House prices
- Traffic
- Pollution levels

Counter Urbanisation is taking place in HICs because:

1. Developed communication network (IT, telephones)
2. Established transport links
3. A range of amenities (coffee shops, gyms, retail)

Counter-urbanisation can lead to impacts such as:

- Improvements are made to key services such as water and gas pipes
- Loss of character
- Potential increase in investment for local businesses
- Rising house prices force locals out of the area

### KPI 9: Is the rural area of Ceredigion sustainable?

Ceredigion is located in West Wales.

As of 2021, Ceredigion is the second least densely populated of Wales' 22 local authority areas, with an area equivalent to around four football pitches per resident.

It's declining population has led to impacts such as:

- Fewer young people in the area means that there are fewer people working.
- Population decline means that local businesses have less people relying on them.
- Schools and healthcare facilities are closing due to population decline.
- There are more cuts in public transport due to fewer people in the area.
- There is an ageing population in the area.
- There is an increase in empty properties.

Year 8 French Module 2 – Shopping and Music

1	Normally I go shopping	Normalement je fais du shopping
2	online and to the shopping centre	en ligne et au centre commercial
3	From time to time I go shopping	De temps en temps je fais du shopping
4	to designer shops	aux magasins de mode
5	because there are more sizes	car il y a plus de tailles
6	Often I buy a dress	souvent <u>j'achète</u> une robe
7	Usually I buy a present	généralement j'achète un cadeau
8	Recently I bought a black hat	Récemment <u>j'ai acheté</u> un chapeau noir
9	I bought a blue T-shirt	<u>j'ai acheté</u> une chemise bleue
10	I bought designer clothes	<u>j'ai acheté</u> des vêtements (de marque)
11	I am going to buy rice	<u>je vais acheter</u> du riz
12	Tomorrow I am going to buy ice-cream	demain je vais acheter de la glace
13	I am going to pay by card	Je vais payer par carte
14	I am going to pay by cash	je vais payer en monnaie

Year 8 French Module 2 – Shopping and Music

15	I always listen to pop music	J'écoute toujours de la musique pop
16	my best friend listens to electronic music	Mon meilleur ami écoute de la musique électronique
17	My mom listens to a singer called...	Ma mère écoute le chanteur qui s'appelle
18	Last year I went to a music festival	L'année dernière je suis allé(e) au festival de musique
19	The first day we danced	Le premier jour on a dansé
20	How lucky	Quelle chance!

**MFL key classroom language:**

Key Word	Student-friendly definition	Example
Infinite	In English it is always accompanied by the word "TO". In Spanish, it always finishes in "R" (-ar/-er/-ir) E.g: to play, to go, to visit, jugar/ hacer / ir / visitar	An opinion is always followed by an infinitive: <b>Me gusta</b> jugar/ hacer/ comprar I like to <b>play/to do/to buy</b> After suelo/solia, you always need an infinitive: <b>suelo ver</b> /jugar/descansar I tend to <b>watch/to play/to rest</b>
Cognate	A word that is similar in spelling and meaning in two languages.	This word is a cognate, what do you think it means? e.g. ciclismo = cycling
Connectives	A word that links two sentences or ideas together, e.g. /y/ or otro /e/o	What connective can we use to link these two sentences? <ul style="list-style-type: none"> <li>Me gusta la historia <b>(pero)</b> odio el inglés</li> <li>I like history <b>but</b> I hate English</li> </ul>
Intensifiers	A word that strengthens the meaning of other expressions and shows emphasis, e.g. muy/bastante	Every time you write an adjective, make sure you use an intensifier before it: <ul style="list-style-type: none"> <li>Creo que las ciencias son <b>muy</b> interesantes</li> <li>I think science is <b>very</b> interesting</li> </ul>

**Example of a French/Spanish LSQ:**

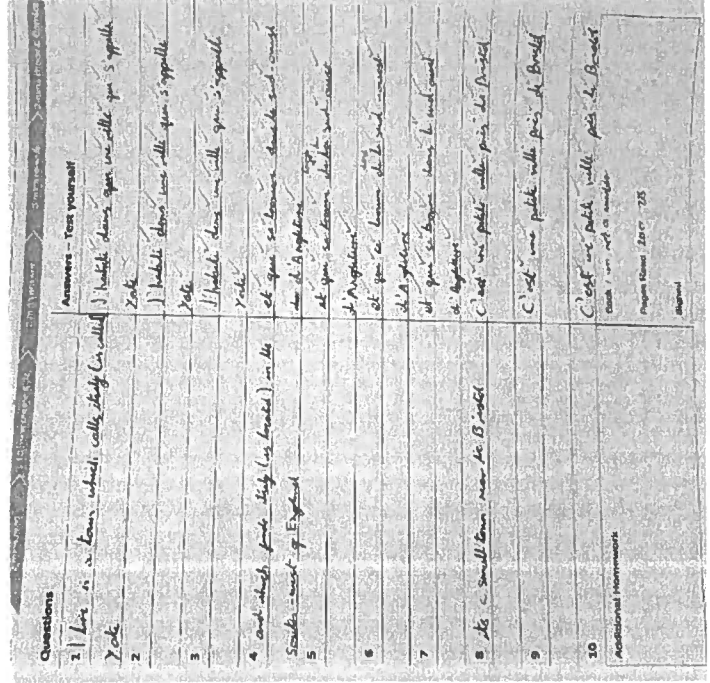

Year 8 Spanish Module 2 – Shopping and Music

1	Normally I go shopping	Normalmente voy de compras
2	to second hand shops because is fashion	A las tiendas de segunda mano
3	From time to time I go shopping	De vez en cuando voy de compras
4	to designer shops	A las tiendas de diseño
5	because there are more sizes	Porque hay más tallas
6	Often I buy a dress	A menudo compro un vestido
7	Usually I buy a present	Generalmente compro un regalo
8	Recently I bought a new hat	Recientemente compré un sombrero nuevo
9	I bought a blue T-shirt	Compré una camiseta azul
10	I bought a magazine	compré una revista
11	I am going to buy a bottle of water	Voy a comprar una botella de agua
12	Tomorrow I am going to buy a box of chocolate	Mañana voy a comprar una caja de chocolates
13	I am going to pay by card	Voy a pagar con tarjeta
14	I am going to pay by cash	Voy a pagar en efectivo

Year 8 Spanish Module 2 – Shopping and Music

15	I always listen to pop music	Siempre escucho la música pop
16	my best friend listens to latin music	Mi mejor amigo/a escucha música latina
17	But my dad prefers a singer called...	Pero mi padre prefiere un cantante que se llama...
18	Last year I went to a music festival	El año pasado fui a un festival de música
19	The first day we danced	El primer día bailamos
20	How lucky	Qué suerte

**MFL key classroom language:**

Key Word	Student-friendly definition	Example
Infinite	In English it is always accompanied by the word "TO". In Spanish, it always finishes in "R" (-ar/-er/-ir) E.g: to play, to go, to visit, jugar/ hacer / ir / visitar	An opinion is always followed by an infinitive: <b>Me gusta jugar/ hacer/ comprar</b> I like to play/to do/to buy After suelo/solia, you always need an infinitive: <b>suelo ver /jugar/descansar</b> I tend to watch/to play/to rest
Cognate	A word that is similar in spelling and meaning in two languages.	This word is a cognate, what do you think it means? e.g. ciclismo = cycling
Connectives	A word that links two sentences or ideas together, e.g. y/ or otro/ pero	What connective can we use to link these two sentences? <ul style="list-style-type: none"> <li>Me gusta la historia (pero) odio el inglés</li> <li>I like history but I hate English</li> </ul>
Intensifiers	A word that strengthens the meaning of other expressions and shows emphasis, e.g. muy/bastante	Every time you write an adjective make sure you use an intensifier before it. <ul style="list-style-type: none"> <li>Creo que las ciencias son muy interesantes</li> <li>I think science is very interesting</li> </ul>

**Example of a French/Spanish LSQ:**

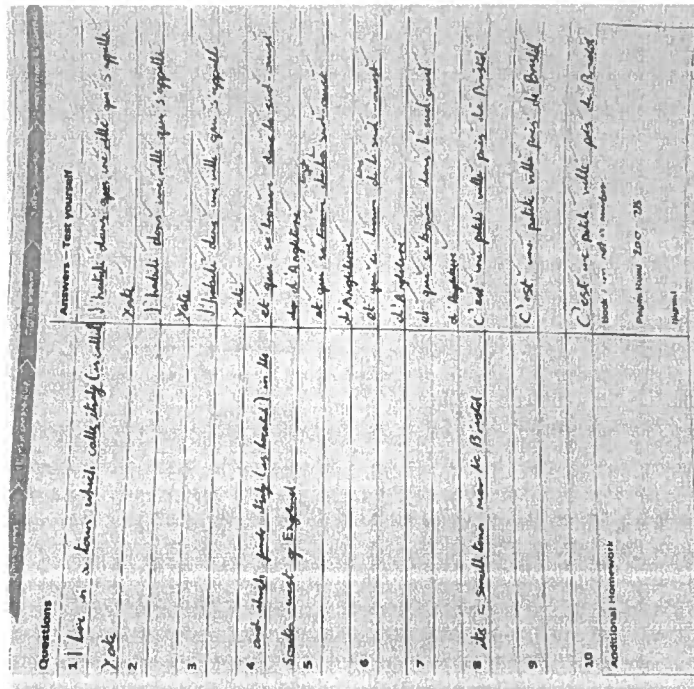

## RE Year 8 Term 3-4 Special journeys

Tourist	a person who is visiting a place for pleasure of interest
Pilgrim	a person who journeys to a sacred place for religious reasons
Pilgrimage	a journey to a place regarded as holy for a believer
Rites of passage	a ceremony or event marking an important stage in someone's life
Lourdes	pilgrimage site of Lourdes is near the Pyrenees mountains in France
Miracle	extraordinary event that breaks the laws of nature
Varanasi	it is located on the left bank of the Ganges (Ganga) River and is one of the seven sacred cities of Hinduism

### KPI1 - To explain the difference between a tourist and a pilgrim

When theists (religious believers) go on pilgrimage they travel somewhere that is special to their faith. It might be to places written about in the sacred writings. It may be a place where a miracle once happened or a saint is buried. Often the journey itself matters as much as being at the special place, because it gives the 'pilgrim' – the person on the journey – time to pray and think. People have always gone on pilgrimage for many reasons – perhaps to say sorry to God for something they had done wrong (penance), or because they were ill looking for an answer to a problem or difficulty.

### KPI 2 : To describe a variety of religious pilgrimages

**Bethlehem** is situated approximately five and a half miles west of Jerusalem. It is the place where Christians believe **Jesus** was born. The most important site in Bethlehem is the Church of the Nativity in Manger Square, which was built in the fourth century. Christian pilgrims travel to Bethlehem, particularly at Christmas time to attend services in the Church of the **Nativity**. Some pilgrims kiss the star representing the birthplace of Christ to show their devotion. **Varanasi** is an ancient city on the banks of the River Ganges in Uttar Pradesh, Northern India. It is one of the most sacred sites in India because it is believed to have been the home of **Lord Shiva**. Millions of pilgrims visit Varanasi in order to **purify** (cleanse) themselves by bathing in the River Ganges at sunrise. **Jerusalem** remains an important place of pilgrimage for Jewish people. Until the destruction of the Second Temple in 70 CE and the Roman occupation of the city after the Bar Kokhba revolt, it used to be a duty for Jewish people to visit Jerusalem three times every year, to coincide with three major Jewish festivals - **Pesach, Shavuot and Sukkot**.

### KPI 3- To analyse whether miracles take place during Lourdes

**Lourdes** is considered a special place to visit because prayers and services are believed to bring real **blessings** to the pilgrim. Pilgrims may visit to be cleansed of their sins and to be **cured** of their illnesses. It is believed that spring water from the grotto can heal people if they are sick. Millions of visitors come to Lourdes each year in the hope of being cured. The International Medical Committee of Lourdes began in 1947 and passes judgement on whether or not any of the healings that take place in Lourdes are **miracles**. By 2015, 69 cases had been recognised as miracles by the Roman Catholic Church. The opportunity to focus closely on their faith helps pilgrims feel secure in the knowledge that God will look after them, forgive them for their sins and even cure them of their illnesses.

### Miracles still happen today

#### Agree

People have been written off by doctors who say that they only have a certain length of time to live. Yet some of these people have made a full recovery.

There have been 69 cases in Lourdes where science and medicine cannot explain why the person has made a full recovery.

These people have been healed because of their faith in the miraculous water of Lourdes.

Jesus performed miracles to people in the past who had faith and prayed. This shows that miracles do exist.

#### Disagree

For a lot of so-called miracles of Jesus there is a logical or scientific explanation. For example, the boy with the evil spirit maybe had epilepsy and Jairus' daughter was probably in a diabetic coma.

People rely on doctors and medical treatments because they know they can cure them. It's a waste of money going to a site of a miracle because they just don't happen.

People today do not place any importance on religion anymore so they don't have faith or pray, therefore miracles can't happen.

**RE Year 8 Term 3-4 Special journeys**

Hajj	Fifth pillar of Islam, performed at least once in the life time
Mecca	Muslim holy city in Mecca/Makkah
Ka'bah	The house of Allah
Ihram	State of purity before Hajj- the sacred state in which Muslims carry out the required rituals (actions) to complete Hajj
Tawaf	Is one of the principal rites of the pilgrimage and refers to circumambulating or walking in circles around the Kaaba in an anti-clockwise motion
Mount of Mercy	Mount Arafat is a granite hill east of Mecca in the plain of Arafat
Jamarat	Three stone walls, formerly pillars, which are pelted as a compulsory ritual of Hajj
Eid- Ul- Adah	Feast of sacrifice
Ummah	Islamic community

**KPI 4: To explain why Hajj is a significant event for Muslims**

Duty – the Hajj is the fifth of the Five Pillars of Islam and is an obligation (action) for all Muslims, at least once in their lives. Once they have completed the Hajj, a Muslim man may call himself a **Hajji** and a woman can call herself a **Hajjah**. Following in the footsteps of the Prophet Muhammad .

Five Pillars of Islam - Hajj is the fifth of the Five Pillars of Islam. As such it reflects a Muslim's devotion, loyalty and belief and therefore helps him or her to grow spiritually. Key belief – the pilgrimage to Makkah reminds Muslims of their key belief in the equality of all humankind before Allah, because each person takes part on exactly the same basis. **Muslim will dress in white – Ihram when beginning Hajj.**

Spirituality - the Hajj prompts Muslims to reflect and think on their own lives. Modern lifestyles are hectic, but the Hajj gives Muslims the opportunity to switch off from work and trivial issues. It also allows Muslims to reconnect with what is really important and focus on spiritual matters.

**KPI5 - To describe the rituals performed during Hajj.**

- The pilgrimage to Makkah is called Hajj and is the fifth Pillar of Islam. Muslims try to go to Makkah during Dhu al-Hijjah, the twelfth month of the Islamic calendar.
- **Ihram** relates to the state of purity and equality before God (Allah) which Muslims enter before going on Hajj. To symbolise this state, male pilgrims wear two lengths of white cloth whilst on Hajj.
- On the first day of the Hajj, pilgrims walk around the **Ka'bah** seven times in an anti-clockwise direction
- Pilgrims next run between the hills of Safa and Marwah seven times. This is to represent the search of Hagar, Ibrahim's wife, for water for her son Ismail.
- Pilgrims travel from Makkah to **Mina** to spend the first night of the Hajj. The next morning they travel on to the plain of **Arafat**, where they stand on or near the **Mount of Mercy** from noon until dusk, praising Allah.
- Pilgrims spend the second night at Muzdalifah, where they collect small stones to use on the third day when they return to Mina. They throw these stones at three pillars called **Jamarat**, which represent the Devil.
- At the end of the pilgrimage, Muslims celebrate the festival of **Eid ul-Adha**.

## Year 8 - Food Technology

### Prevention of Bacteria Growth and Cross Contamination

4 C's	Chill – foods to be kept in the fridge: dairy, protein, high risk foods / Cook – cook foods properly / Cross Contamination / Clean
Food Temperature Control:	Temperature control is especially important when you buy, store, prepare and cook food. Food correctly stored will minimise the risk of food spoilage and food poisoning. Food poisoning can be caused by high-risk foods when they are stored in warm conditions for too long. Controlling the temperature of food will help keep your food safe until it is ready to be eaten. Bacteria growth danger zone 5-63 degrees C. Most bacteria dead at 75 degrees C. All dead at 100 degrees C. Fridge temperature 0-5 degrees C
Sources of Cross Contamination:	Human: Hair, nose, cuts, wounds, ears, throat, clothing, jewellery, dirty hands (bacteria) after touching raw meat/going to the bathroom.
Bacteria needs:	Other: Pets, Dirt, Birds, Vermin (mice/rats), Insects, bacteria from raw meat and seafood.
Chopping Boards	Heat, Moisture, Time and Food to grow/survive.
	Chopping boards: Red = raw meat, Blue = raw fish, Brown/Green = fruit and vegetables, Yellow = Cooked meat/fish, White = Dairy

### Eatwell Guide Key Messages

Eatwell Guide / Use the Eatwell Guide to help you get a balance of healthier and more sustainable food.	<p><b>Carbohydrates:</b> Starchy foods such as, rice, pasta, potatoes, bread, porridge, couscous – Choose wholegrain or higher fibre versions with less added fat, salt, and sugar.</p> <p><b>Fruits and Vegetables:</b> Fresh, frozen, dried, canned – Eat at least 5 portions of a variety of fruit and vegetables every day. Fruits and vegetables contain vitamins and minerals</p> <p><b>Protein:</b> Chicken/poultry, fish – fresh and canned (tuna), meat, eggs, chickpeas, lentils, beans. Eat more beans and pulses, 2 portions of sustainably sourced fish per week, one of which is oily. Eat less red and processed meat. The body uses protein to build and repair muscles. Protein contains amino acids.</p> <p><b>Dairy and Alternatives:</b> Milk, yoghurt, cream, cheese, alternative milks: almond, rice, coconut, hazelnut, soya. Choose lower fat and lower sugar options. These foods contain calcium which is needed in the body for strong bone growth.</p> <p><b>Fats:</b> Choose unsaturated oils not saturated oils and use in small amounts – sunflower, olive, rapeseed. Saturated oils come from animal meat and animal products such as butter. Too much of this type of oil can clog the body's arteries and lead to weight gain, high blood pressure and heart disease. Fats are higher in calories than protein and carbohydrates.</p> <p>Sugary foods/crisps/ketchup – eat less free sugars often and in small amounts.</p> <p><b>6-8 cups of water:</b> lower fat milk, sugar-free drinks including tea and coffee all count.</p>
---	--

### Macronutrients and Micronutrients

Macronutrients are: Carbohydrates, Protein and Fats	<p>Food is eaten and digested in the body to allow the absorption of energy and nutrients.</p> <p><b>Macronutrients are:</b> proteins, carbohydrates and fats and are measured in grams. Carbohydrates are the primary source of energy. 1gram = 4 calories</p> <p>Protein is the secondary source of energy. They are also needed for the growth of the skeleton, strong bones, teeth and hair. 1gram = 4 calories. Fats are the third source of energy. They are also needed in small quantities to keep the body warm and protect the organs. 1 gram = 9 calories. There are two types of fats: saturated and unsaturated. Saturated fats mainly come from animal products, for example, bacon fat, chicken skin and crispy cracking. Unsaturated fats mainly come from plant foods, for example, sunflower oil, olive oil, nuts and seeds.</p>
---	--

## Year 8 - Food Technology

### Micronutrients are: Vitamins and Minerals

**Micronutrients are:** vitamins and minerals. **Vitamins:** Vitamins ADEK are water soluble. Vitamins B and C are fat soluble. **Vitamin A:** helps us with our night vision, healthy skin and eyes, helps us with resistance to infection. Found in carrots, cheese, eggs, milk products. **Vitamin B1 (Thiamin)** is needed for a healthy nervous system and to release energy from carbohydrates. Found in wholegrains, nuts, pork, fortified cereal, fruit and vegetables. **Vitamin B2 (Riboflavin)** is needed to release energy from protein, carbohydrate and fat. It also helps transport iron around the body. Found in milk, eggs, rice, fortified cereals, green vegetables. **Vitamin B3 (Niacin)** needed for the release of energy from foods, normal function of the skin and the nervous system. Found in meat, eggs, dairy, yeast, wheat and maize flour. **Vitamin C:** needed to make collagen for healthy structure of skin and cartilage. Also helps the body absorb iron and helps wounds heal. Found in citrus fruits and berries, green vegetables, peppers, tomatoes, new potatoes. **Vitamin D** is needed for the body to absorb calcium to keep our bones healthy. We take most of our vitamin D from the sun but can also be from mushrooms, oily fish, meat and eggs. **Minerals Calcium:** Required for bone structure, blood clotting, normal muscle function, healthy teeth. Found in dairy products, fortified nut milks, eggs. **Iron:** Iron is essential for the formation of haemoglobin in red blood cells. Red blood cells carry oxygen and transport it around the body. Iron is also required for normal metabolism and removing waste substances from the body.

### Glossary of Key Terms:

**Food spoilage** – when food deteriorates to the point that its quality is reduced or it can no longer be safe to eat. **High Risk Foods** – Ready to eat moist foods - pasta, rice, seafood, poultry, protein, dairy, sauces/gravy. **Cross Contamination** – the process by which bacteria or other microorganisms are unintentionally transferred from one substance or object to another, with harmful effects. **Hot Conduction Heat** – to transfer heat to cook food through either air or water **Oven Convection Heat** - to transfer heat to cook food through a solid **Rubbing In** – to combine fat with flour to make a breadcrumb-like consistency. **Creaming** – to combine sugar and soft fat (butter). **Coating** - to cover (for example, breadcrumbs around fish for fish fingers). **Emulsification** - to combine and stabilise two ingredients together that would usually split apart - oil/egg yolk **Simmering** – to heat liquids to just below the boiling point. **Dietary fibre** - a type of carbohydrate which is not digested to provide energy. **Free sugars** - include all sugars added to foods plus sugars naturally present in honey, syrups, and unsweetened fruit juice. **Starch** is found in a variety of carbohydrate foods. It is made up of many sugar molecules. **Amino Acids** - Protein is made up of building blocks - amino acids. Different foods contain different amounts and different combinations of amino acids. **Haemoglobin** - a red protein responsible for transporting oxygen in the blood. **Metabolism** - chemical reactions within the body that help maintain the living state of cells.

# DESIGN & TECHNOLOGY

## 1: Joining Methods

Wood joints can be either permanent or temporary depending on the type and if glue is used.

Permanent:	Temporary:
When we do not want to take the pieces apart again	When we will, or might need to take pieces apart again
Glues, welding, rivets	Screws, bolts, nails

### 1.1 Wood Joints

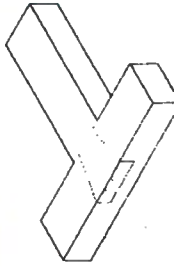
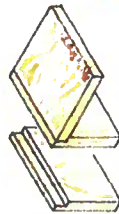

**Lap Joint**      Mortise + Tenon Joint      Dovetail Joint

## 2. Scales of Production

**One off:** when you make a unique item

**Batch:** when you make a few/set amount

**Mass:** when you make thousands

**Continuous:** open ended production

## 3. Adhesives

**P.V.A.** – Poly Vinyl Acetate – best for joining 2 pieces of wood together

**Epoxy** – a thermosetting resin that can be used to bond most types of material

**Contact Adhesive** – a glue type that creates a tacky bond on both surfaces to be joined. It can be used with most materials.

## 4: Materials

### 4.1 Woods:

Hardwoods:	Softwoods:
Beech Oak Ash	Scots Pine Cedar Spruce

### 4.2 Engineered Boards

Engineered boards are manmade materials usually made by mixing wood chips and glues to make wooden sheets.

Examples:

Medium Density Fibreboard (MDF)  
Chipboard, Plywood and **Hardboard**

### 4.3 Plastics

Plastics are made of polymers, and are mostly refined from oil. There are 2 main categories:

Thermoplastics	Thermosetting plastics
Acrylic	Urea Formaldehyde
Polypropylene (PP)	Melamine Formaldehyde
High Impact Polystyrene (HIPS)	Epoxy Resin

### 4.4 Metals

Metals are hard and usually shiny, containing one or more elements dug and refined from the ground

Ferrous metals are any metal that contains iron and will rust  
Non-Ferrous metals do not contain iron and will not rust

Alloys are metals made from a mix of 2 metals – brass is made of copper and zinc.

**Composite materials** are a mix of 2 different types of material to get the best qualities from each – eg: GRP (Glass Reinforced Plastic)



Try square



Bench Hook

## 5: TOOLS



Vice



Mallet



Chisel



Laser Cutter



Router Table

Tenon Saw

## 6: Surface Finishes

Finishing is usually one of the last stages of making a project. It will usually involve sanding and applying a surface coating to **protect** your material and **improve its visual appearance**.

Some examples:

Paint, Stain, Varnish, Oil, **Danish Oil**, Wax, Polish & Dip Coating.

## 7: KEY WORD FOCUS

You should be able to explain the meaning of each of these words by the end of this rotation.

CAD	Computer Aided Design
CAM	Computer Aided Manufacture
CNC	Computer Numerical Control

**ART Year 8 - Term 2 - Cultures Project/ Places & Objects**

<u>Formal Elements</u>	<u>Poly-Tile Printing</u>	<u>Keywords</u>	<u>Aboriginal Art</u>
<p><b>Line</b> A mark that connects two or more points. These can be straight, curved, short or long.</p> <p><b>Tone</b> The lightness or darkness or something. For darker tones use a higher grade B pencil.</p> <p><b>Colour</b> Colour is what you see when light reflects off something.</p> <p><b>Texture</b> How something looks or feel e.g. fluffy, rough, smooth etc.</p> <p><b>Pattern</b> A symbol, shape or colour that repeats. Man-made patterns are designed by humans, natural patterns are formed by nature.</p> <p><b>Shape/Form</b> Shape is 2D e.g. rectangles. Form is 3D e.g. cubes, spheres etc.</p>	<p><b>Poly (Polystyrene) Tile</b> Versatile plastic sheets</p> <p><b>Type of print</b> Relief Printing (printing from a raised image)</p> <p><b>Technique</b> Carving/cutting into a surface. Carved/cut areas remain untouched by ink, only recessed area transfers colour.</p>	<p><b>Clay</b> A stiff, sticky fine-grained earth that can be moulded when wet.</p> <p><b>Kiln</b> a furnace or oven used to fire pottery Ceramic made of clay and permanently hardened by heat.</p> <p><b>Glaze</b> a substance used to add colour, decorate or waterproof a piece of ceramic work.</p> <p><b>Slip</b> Watered down clay which is used as a type of glue to stick one piece of clay to another.</p> <p><b>Carving</b> A shape or pattern cut into a specific material.</p> <p><b>Layering</b> Laying one material on top of another (building up)</p> <p><b>Proportion</b> The size and relation of objects to one another. Using the grid-method is one way of helping you draw using accurate proportions.</p>	<p><b>Aborigines</b> Indigenous peoples, ethnic groups who are the original or earliest known inhabitants of an area (Australia)</p> <p><b>Time</b> First Aboriginal Rock Painting dates back to 1620 but only developed in 1971 as Dot paintings.</p> <p><b>Country (origin)</b> Australia</p> <p><b>Technique/Style</b> The 'Dot' is used to hide secret messages.</p> <p><b>Intentions</b> Originally, artists used circles and dots to disguise sacred meanings and messages especially from the Western countries, e.g. America, Great Britain etc.</p> <p><b>Key Artist</b> Sarita King</p> <p><b>Artist Influence</b> Aboriginal dotting technique and changing climate of Australia e.g. lightning, thunderstorms, deserts, wild fires etc.</p>

<p><b>Colour Theory</b></p> <p><b>Primary Colours</b> Colours that can't be mixed/ made from other colours e.g. red, yellow and blue.</p> <p><b>Secondary Colours</b> Colours that can be made by mixing two primary colours. Red + Blue = Purple Yellow + Blue = Green Yellow + Red = Orange</p> <p><b>Tertiary Colours</b> Colours that can be made by mixing a primary and secondary colour together e.g. Blue + Green = Turquoise.</p> <p><b>Complementary Colours</b> Colours that are opposite each other on the colour wheel. Blue &amp; Orange Red &amp; Green Purple &amp; Yellow</p> <p><b>Analogue/ Harmonious Colours</b> Colours that are next to each other on the colour wheel e.g. Red, red-orange and orange.</p> <p><b>Tints/ Shades</b> Tint - Adding white to a colour to make it lighter. Shades - Adding black to a colour to make it darker.</p>	<p><b>More Keywords:</b></p> <p><b>Bisque Ware</b> Fired clay that is ready to be glazed.</p> <p><b>Rolling Guides</b> Wood slats used when rolling clay to give it an even thickness.</p> <p><b>Ceramics</b> Any artwork produced using clay.</p> <p><b>Composition</b> This is where you place objects on a page. You can explore different layouts such as close up, far away, busy, quiet, off centred, clustered.</p> <p><b>Composition Examples:</b> <b>Foreground</b> = closest thing to a viewer <b>Midground</b> = section in between the fore- and background. <b>Background</b> = the furthest thing in the distance to a viewer.</p> <p>Fore-, mid- and background are compositional techniques which help to create distance in a landscape.</p> <p><b>Cropped</b> = a picture doesn't appear fully as the edges look like they have been cut off.</p> <p><b>Zoomed in</b> = object is close up and therefore you may only see parts of it.</p>	<p><b>Places &amp; Objects - Tips, Tools &amp; Techniques</b></p> <p><b>Types of Perspective</b> The difference between one- and two-point perspectives is the number of vanishing points on the horizon line. A vanishing point is a spot on the horizon where all receding parallel lines appear to meet or disappear</p> <p>A bird's-eye view is an elevated view of an object from above, with a perspective as though the observer were a bird, often used in the making of blueprints, floor plans, and maps. It can be an aerial photograph, but also a drawing.</p> <p><b>Grid-Method</b> A method of drawing to recreate, enlarge or reduce an image ensuring accurate proportions.</p> <p><b>Mono-Printing</b> A form of printmaking that has lines or images that can only be made once.</p>	<p><b>Places &amp; Objects Keywords &amp; Concepts</b></p> <p><b>Architecture</b> Architecture is both the process and product of planning, designing and construction. For this project we will be focusing on buildings from our local area, as well as looking at some historic or contemporary buildings around the world.</p> <p><b>Composition</b> This is where you place objects on a page. You can explore different layouts such as close up, far away, busy, quiet, off centred, clustered.</p> <p><b>Watercolour Wash</b> Diluting watercolours by adding more water to make them lighter.</p>
---	--	---	--

## DRAMA year 8 - Romeo and Juliet

PLOT	CHARACTERS	THEMES AND CONTEXT	SYMBOLISM AND KEY TERMS
<p><b>Act 1</b> - In Italy two noble families, the Montagues and Capulets, have much bad blood between them. Romeo, son of old Montague, is in love with Rosaline, who disdains his love. As a result, Romeo is depressed. To cure him of his love, his friend Benvolio induces him to attend a masked ball at the Capulets, where he could encounter other beauties and forget Rosaline. At the ball, Romeo is attracted by a girl who he learns is Juliet, daughter of the Capulets. They seal their love with a kiss.</p>	<p><b>Romeo Montague</b> - Intense, intelligent, quick witted, and loved by his friends.</p> <p><b>Juliet Capulet</b> - Naïve and sheltered at the beginning, develops into a woman with strength. Grounded.</p> <p><b>Mercutio</b> - Romeo's close friend. Wild, playful and sarcastic</p> <p><b>Tybalt</b> - Juliet's cousin. A hothead consumed by issues of family honour. Hates the Montagues.</p> <p><b>Benvolio</b> - Romeo's cousin, less quick witted than Romeo and Mercutio, tries to keep the peace.</p> <p><b>Friar Laurence</b> - A Franciscan monk and a friend to both Romeo and Juliet.</p> <p><b>Nurse</b> - Juliet's best friend and confidante, and in many ways is more her mother than Lady Capulet is.</p> <p><b>Prince Escalus</b> - Leader of Verona, concerned with keeping order between the warring families.</p> <p><b>Paris</b> - Nobleman given permission to woo Juliet initially, then to marry her after Tybalt's death. Killed by Romeo.</p> <p><b>Lord Capulet</b> - Patriarch of the Capulets, counterpart to Lord Montague. Arranges marriage for Juliet, quick to anger when disobeyed.</p> <p><b>Lord Montague</b> - Romeo's father, despises the Capulet family and would never approve of the union between the star crossed lovers.</p> <p><b>Balthazar</b> - Romeo's friend who delivers the news that Juliet has died.</p>	<p><b>Love</b> - The love Romeo and Juliet share is beautiful and passionate. It is pure, exhilarating, and transformative, and they are willing to give everything to it. But it is also chaotic and destructive, bringing death to friends, family, and to themselves. Alternative attitudes to love are offered through Mercutio's cynicism and innuendo, and the Nurse's often bawdy, physical references. Familial love can be explored, especially with Juliet's relationship to her parents.</p> <p><b>Fate</b>- No matter what the lovers do, what plans they make, or how much they love each other, their struggles against fate only help fulfill it. But defeating or escaping fate is not the point. No one escapes fate. It is Romeo and Juliet's determination to struggle against fate in order to be together, whether in life or death, that shows the fiery passion of their love, and which makes that love eternal.</p> <p><b>Individuals v society</b>- Because of their forbidden love, Romeo and Juliet are forced into conflict with the social world around them: family, friends, political authority, and even religion.</p> <p><b>Violence / Conflict</b> – The play opens in a violent street fashion. The blood feud between the two families features in the prologue. The romance between Romeo and Juliet brings many deaths until the eventual death of the two protagonists.</p> <p><b>Language and word play</b>-Romeo and Juliet constantly play with language. They pun, rhyme, and speak in double- entendres. All these word games may seem like mere fun, and they are fun. The characters that pun and play with language have fun doing it. But word play in <i>Romeo and Juliet</i> has a deeper purpose: rebellion. Romeo and Juliet play with language to escape the world.</p>	<p><b>Light and Dark/Night and Day</b> - <i>Romeo and Juliet</i> is filled with imagery of light and dark. But while light is traditionally connected with "good" and dark with "evil," in <i>Romeo and Juliet</i> the relationship is more complex. Romeo and Juliet constantly see each other as forms of light. In the balcony scene, Romeo describes Juliet as the sun, while Juliet describes Romeo as stars. But the relationship between light and dark is complicated by the lover's need for the privacy of darkness in order to be together.</p> <p><b>Prologue</b> - an opening of a play that establishes context and gives background details.</p> <p><b>Foreshadowing</b> - a warning or indication of a future event.</p> <p><b>Dramatic irony</b> - originating from Greek tragedies, a technique whereby the audience is aware of a piece of information that is still unknown to the characters.</p> <p><b>Monologue</b> - a long speech by one actor</p> <p><b>Soliloquy</b> - the act of speaking one's thoughts aloud when by oneself regardless of who is listening, usually for the benefit of the audience (a Shakespearean version of thought tracking)</p> <p><b>Direct address</b> - when a character breaks the metaphorical fourth wall and speaks directly to the audience</p> <p><b>Iambic Pentameter</b> - a line of verse/poetry with 10 syllables whereby one short (unstressed) syllable is followed by a longer (stressed) syllable</p> <p><i>All of the techniques listed above were prominent in almost all of Shakespeare's plays. They may seem completely normal in modern performances but at the time, Shakespeare was praised for the innovative ways of presenting a play in a way that engaged audiences of all classes. His plays were just as accessible to the poor as they were to the rich, which is another reason why his work has aged well and is still studied all across the world.</i></p>
<p><b>Act 2</b> - Romeo lingers in Capulet's garden, standing in the orchard beneath Juliet's balcony. He sees Juliet leaning over the railing, hears her calling out his name, and wishes that he were not a Montague. He reveals his presence, and they resolve, after an ardent love scene, to be married secretly.</p>			
<p><b>Act 3</b> - Tybalt encounters Romeo returning from Friar Lawrence's cell. Romeo, softened by his newfound love and his marriage to Juliet, refuses to be drawn into a quarrel with Tybalt, now his kinsman by marriage. Mercutio grapples with Tybalt and is killed. Aroused to fury by the death of his friend, Romeo fights with Tybalt and kills him and takes shelter in the Friar's cell.</p>			
<p><b>Act 4</b> - In despair, Juliet seeks Friar Lawrence's advice. He gives her a sleeping potion, which for a time will cause her to appear dead. Thus, on the day of her supposed marriage to Paris, she will be carried to the family vault. By the time she awakens, Romeo will be summoned to the vault and take her away to Mantua.</p>			
<p><b>Act 5</b> - The Friar's letter fails to reach Romeo. When he hears of Juliet's death Romeo procures a deadly poison from an apothecary and secretly returns to Verona to say his last farewell to his deceased wife and die by her side. At Juliet's side, Romeo drinks the poison and dies. When Juliet awakens from her deep sleep, she realises Romeo's error and kills herself with his dagger. The Capulets and Montague decide to reconcile as a result of the deaths of their children.</p>			

## Five Key Acting Skills

**Facial Expressions** - How can we show emotions through our faces? Eye contact, eye brows, straight, emotions, gritting teeth, tense, relaxed, wrinkled, creased, staring, twitching.

**Voice** - How can we use our voice in performance? Tone, pitch, pace, emotion, volume, projection, dialogue, dialect, accent, intonation, whistling, SFX, interjection.

**Posture** - How can we use our bodies to help us create performance? Posture, blocking, positioning, front on, side on, emotions, age, open or closed.

**Gestures** - These are movements with meaning, how can we use them in performance? Hands, arms, speed, clicking, rubbing, waving, mannerisms.

**Movement** - How can movement be used to create performance? Speed, pace, acceleration, gait, mannerisms, special awareness, stage presence.

## Key Terminology

**Script** - The written words and stage direction which are spoken and performed in a play. A script will be written by a writer and then given to a director to create a performance.

**Director** - This is the person who is in charge of the actors and performers. The director will tell the actors how they want them to perform and move in each scene. They will block the performance.

**Blocking** - When creating a performance you must first plan where all the actors are going to be standing and moving to on the stage. You must also plan what set and props are going to be used in your performance. This is called Blocking.

**Stage Direction** - Text in a script which tells you what you need to be doing while performing. Some scripts may have more stage directions than others. Some directors may also decide not to use all of the stage directions because they have their own ideas for what the performers should be doing.

**Characterisation** - Using a variety of skills, improvisation techniques and background information to become your character. These skills are your 5 key acting skills. It is important you fully understand the character you are performing. You MUST remember, you are no longer yourself when acting. You become someone else.

**Performance Discipline** - Maintaining extremely high and professional levels of focus and concentration throughout rehearsals and performance. This involves being on task at all times, not laughing or giggling when you are acting. It is crucial to stay focused when performing.

**Ensemble** - A group of performers all working together in a performance.

**Freeze Frame** - When a scene 'freezes' for a moment to allow the audience to really explore the moment. It is like pressing pause on live action.

**Tableaux** - A collection of still images which create a performance. It is like looking through a photo album.

**Immersive theatre** - Audience are included in the performance but don't know what is going to happen. Actors may talk to or ask the audience questions about what is happening in the performance.

## Example Self-evaluation

**STRENGTH** During my performance, I wanted to show how my character was really angry with another character. To do this, I scrunched my eyebrows together and tilted my head slightly forward, using facial expression to show my annoyance. I also had a very big frown and narrowed whilst making a low pitched noise to display my frustration. This was successful because the audience could clearly see how angry my character was when seeing their friend after having an argument.

**AREA FOR IMPROVEMENT** During my performance, I wanted to show how my character was really happy to see someone. To do this, I slowly waved my hand and had a slight smile on my face whilst quietly saying 'Hello' in a soft tone. My intention was to show how I was happy but wanted to show it in a subtle way. However, the audience were confused by this and thought that my reaction was too small. If given the chance to perform this moment again, I would make my gestures much bigger, my movements quicker and my facial expressions much more exaggerated so that the audience can see my excitement much more clearly.

# PCSHE – Year 8 Term 2 – Identity and Relationships

## KPI1: Key Terms

- **Consent:** Consent is a person’s permission or agreement by choice to anything that informs them. Consent must be freely given, it is reversible, it must be informed, enthusiastic and very specific.
- **Underage:** Under the age of 16.
- **Age of consent:** The age where someone can legally agree to taking part in sexual activity. In the UK the age of consent is 16.
- **Legislation:** the law
- **Prosecuted:** to bring legal action against a crime or punishment of a crime for the breaking of a law.
- **Contraception:** Birth control, also known as contraception, is the use of methods or devices used to prevent unintended pregnancy.
- **Gender Identity:** Gender identity is an individual person’s sense of their gender; it is how they experience, feel, view and label it. It is unique to each person and is separate from the sex they were registered with at birth, although someone’s gender identity may align with this.
- **Sexual Orientation:** Sexual Orientation relates to romantic attraction. Examples of sexual orientation can include:
  - **LGBTQA+:** The letters stand for: lesbian, gay, bisexual, transgender, queer/questioning, asexual, and many other terms that people may use to define their sexual attraction or gender identity.
  - **Cisgender:** Someone whose gender identity is the same as their birth sex.
  - **Transgender:** Someone whose gender identity is the different to their birth sex.

## KPI2 – What is consent?

Consent is a person’s permission or agreement by choice to anything that informs them. For example, their body, personal space, time, money and belongings.

We all have the right to be asked for consent in situations that involve us, and the responsibility to ask others for consent in situations that involve them. Consent is important because it gives people **choice** and **control** over decisions that affect them.

### Consent is:

- Freely given. It’s not okay to pressure, trick, or threaten someone into saying yes.
- Reversible. It’s okay to say yes and then change your mind — at any time!
- Informed. You can only consent to something if you have all the facts.
- Enthusiastic. You should do stuff you WANT to do, not things people expect you to do. If someone doesn’t seem enthusiastic stop and check in.
- Specific. Saying yes to one thing (like going to the bedroom to make out) doesn’t mean you’re saying yes to other things (like having sex).

### Consent cannot be given when:

- When a person is drunk or high, to the point that they are unable to speak or look after themselves.
- Asleep or Passed Out – if they are not conscious they are unable to agree to any sexual activity. If someone passes out whilst engaging in sexual activity – STOP!
- They are Underage – Legally a person under the age of 16 cannot give consent to any sexual activity.
- Mental disability or learning difficulties which mean they are unable to fully understand what they are consenting to.

## KPI3 – Consent and the Law

In the UK, the age of consent is 16. This means that a person under the age of 16 cannot legally consent to sexual activity because they are seen as not having the capacity to do so. The law applies to everyone, regardless of gender or sexual orientation in England, Wales, Scotland and Northern Ireland.

The law is designed to protect young people from abuse, harm of being taken advantage of. If someone is under the age of 16 and decides to have sex anyway, it is still vital that they and their partner(s) are able to consent to sex in every other capacity.

According to the law, there are no circumstances in which someone under the age of 13 can consent to any sexual activity or act.

## KPI4: Sexting

**Sexting:** Sexting is the sending or posting of nude or semi-nude images, videos or live streams online by young people under the age of 18. This could be via social media, gaming platforms, chat apps or forums. It could also involve sharing between devices via services like Apple’s AirDrop which works offline.

### What is the law about sexting?

In the UK the age of consent for sexual intercourse is 16. However, it is an offence to make, distribute, possess or show any indecent images of anyone aged under 18, even if the content was created with the consent of that young person. The law is contained in **Section 1 Protection of Children Act 1978**. ‘Indecent’ is not defined in law. When cases are prosecuted, the question of whether any photograph of a child is indecent is for a jury, magistrate or district judge to decide. Indecent imagery does not always mean nudity.

### Will I get in trouble?

You can get in trouble if you threaten to share a nude, even if you don’t actually do it. Only the police can decide if they’re going to charge you with an offence after sexting. But it’s important to remember that the law is there to protect you, not get you into trouble.

## PCSHÉ – Year 8 Term 2 – Identity and Relationships

### KPI3 – Types of Contraception

Birth control, also known as contraception, is the use of methods or devices used to prevent unintended pregnancy.

Birth control	How to use	Prescription Needed	Protects against STIs
Oral Contraceptive	Take one pill every day as directed	Yes	No
Injection	Get injections every three months	Yes, injection given in health care providers office	No
Female condom	Insert every time before sex	No	Yes
Male condom	Partner must wear every time during sex	No	Yes

### KPI5: Sexual Orientation and Gender Identity

#### Gender Identity:

Gender identity is an individual person's sense of their gender; it is how they experience, feel, view and label it. It is unique to each person and is separate from the sex they were registered with at birth, although someone's gender identity may align with this.

Important definitions:

- **Biological Sex:** The physical anatomy and gendered hormones one is born with.
- **Cisgender:** A description for a person whose gender identity, gender expression and biological sex all align.
- **Gender Dysphoria:** where a person experiences distress due to a mismatch of their biological sex and their gender identity.
- **Intersex:** A person with a set of sexual anatomy that doesn't fit within the labels of female or male (e.g. XXV phenotype, uterus, and penis)
- **Transgender:** A person whose gender identity is the binary opposite of their biological sex, who may undergo medical treatments to change their biological sex.
- **Gender Identity:** A way to describe how you feel about your gender. You might identify your gender as a boy or a girl or something different. This is different from your sex, which is related to your physical body and biology.

People do not necessarily identify as only 'male' or 'female'. There are a number of different labels that people may use to describe their gender.

#### Sexual Orientation:

Sexual Orientation relates to romantic attraction. Examples of sexual orientation can include:

- **Asexual:** A person who generally does not experience sexual attraction to any group of people.
- **Bisexual:** A person who experiences sexual, physical and/or spiritual attraction to people of their own gender as well as another gender.
- **Heterosexual:** A person who is attracted to someone with the other gender.
- **Homosexual:** A person who is attracted to someone with the same gender.
- **Pansexual:** A person who experiences sexual, romantic, physical, and/or spiritual attraction for members of all gender identities/expressions.

### KPI6 – Legal Changes that have affected LGBTQ+ people in the UK:

- 2000: Government lifts the ban on lesbians and gay men serving in the Armed Forces.
- 2001: Age of consent for gay/bi men is lowered to 16.
- 2002: Equal rights are granted to same-sex couples applying for adoption.
- 2003: Repeal of Section 28 - Section 28 was a law that made it illegal to talk positively about homosexuality in schools.
- 2003: A new law comes into force protecting LGBT people from discrimination at work. Until 2003 employers could discriminate against LGBT people by not hiring them or not promoting them, just because of their sexual orientation or gender identity.
- 2004: Civil Partnership Act is passed.
- 2004: Gender Recognition Act is passed - This Act allowed trans people to change their legal gender. This means that they can get a new birth certificate that reflects who they really are, which helps for future legal processes like marriage.
- 2007: It becomes illegal to discriminate against people because of their sexual orientation or gender identity when providing them with goods or services.
- 2008: The Criminal Justice and Immigration Act makes 'incitement to homophobic hatred' a crime.
- 2009: A new law gives better legal recognition to same-sex parents.
- 2013: The Marriage (Same-Sex Couples) Act is passed.

#### Where to get more help and support:

- Parents and trusted family members
- Teachers and School Staff including School Nurse and Safeguarding Team
- Your Doctor or Community Nurse
- NHS Online
- Young Stonewall: <https://www.youngstonewall.org.uk/>
- The Proud Trust – Local Support groups: <https://www.theproudtrust.org>
- Friends and Family of Lesbians and Gays: <https://www.ffiag.org.uk/>
- [www.healthforteens.co.uk](http://www.healthforteens.co.uk)
- [www.brook.co.uk](http://www.brook.co.uk)
- **NSPCC: Helpline: 0800 800 5000 (24 hours, every day)** [nspcc.org.uk](http://nspcc.org.uk)
- **Childline: Helpline: 0800 1111(24 hours, every day)** <https://www.childline.org.uk>

# PCSHE – Year 8 Term 4 – Mental Health

## KPI 1 - Key terms:

- Body image: The perception that a person has of their physical self and the thoughts and feelings that result from that perception.
- Social Media: Websites and applications that enable users to create and share content or to participate in social networking.
- Mental wellbeing: Mental wellbeing describes your mental state - how you are feeling and how well you can cope with day-to-day life. Our mental wellbeing is dynamic. It can change from moment to moment, day to day, month to month or year to year.
- Emotional literacy: The ability to understand and express feelings. It involves having self-awareness and recognition of one's own feelings and knowing how to manage them.
- Digital resilience: Involves having the ability to understand when you are at risk online, knowing what to do if anything goes wrong, learning from your experiences of being online, and being able to recover from any difficulties or upsets.

## KPI 2- Things that can affect our mental wellbeing:

Everyone is different and what affects someone's mental wellbeing won't necessarily affect others in the same way. Everyone will have times when they have low mental wellbeing, where they feel stressed, upset or find it difficult to cope.

Common life events that can affect your mental wellbeing include:

- loss or bereavement
- loneliness
- relationship problems
- issues at work
- worry about money

However, there are times when there is no discernable reason for the way a person feels which can be extremely frustrating.

There are some factors that may make people more vulnerable to experiencing a period of poor mental wellbeing. These may have happened in the past or might still be happening now:

- Childhood abuse, trauma, violence or neglect
- Social isolation or discrimination
- Homelessness or poor housing
- A long-term physical health condition
- Social disadvantage, poverty or debt
- Unemployment
- Caring for a family member or friend
- Significant trauma as an adult, such as military combat, being involved in a serious accident or violent crime

## KPI 3 – Digital Resilience

### How does going online affect young people?

Like all aspects of our lives, going online conjures up a huge range of emotions and responses that can impact our mood and well-being. Someone could be pleased to see photos of their friend having a great time on holiday but at the same time they may feel envious because they are not there or have never been to such a place.

### Why is digital resilience important?

Digital resilience gives everyone the ability to recognise when going online is having a negative impact and the strategies to bounce back and recover. If a someone realises that the balance has shifted and going online is not making them feel supported, empowered and happy we want them to have a variety of people and techniques that they can turn to.

### Digital Resilience Tips

- Build a support network – reach out to someone and support others too. A problems shared is a problem halved.
- Find useful sites/organisations who can help give yourself a break.
- Give yourself a break – you are not perfect and will make mistakes. Be kind and fair to yourself. Take some time offline if you want to.
- Sort out disagreements quickly.
- Lifestyle changes – make time for things and people that make you happy.
- Look out for new challenges – life can be hectic. Find ways to help you relax
- Physical health – get some exercise, be active.
- Put your devices away at night to get a good night's sleep.
- Eat regularly and healthily.
- Protect your online reputation - Use the services provided to manage your digital footprints and 'think before you post.' Content posted online can last forever and could be shared publicly by anyone.
- Know where to find help - Understand how to report to service providers and use blocking and deleting tools. If something happens that upsets you online, it's never too late to tell someone.
- Don't give in to pressure - Keep calm and keep in control; once you've pressed send you can't take it back.

## For further support...

### Home/school support:

A friend; A teacher; Your tutor;  
Parents/carers; Mr Ogden Mrs Jones;  
Mrs Loveridge; Mr Hayward

### Self-help apps

- Calm Harm – Managing Self-Harm
- MindShift – to manage anxiety and urges to self-harm
- Cove – express your mood with music
- Stress and Anxiety Companion – helps you to manage stress and anxiety
- Chill Panda – relaxation and breathing exercises.

### Reputable organisations:

- - Child Bereavement UK – call 0800 028 8840 Monday to Friday, 9am to 5pm, or email [support@childbereavement.org](mailto:support@childbereavement.org)
- Cruse Bereavement Care – call 0808 808 1677 Monday and Friday, 9.30am to 5pm, and Tuesday, Wednesday and Thursday 9.30am to 8pm, or email [info@cruse.org.uk](mailto:info@cruse.org.uk)
- Grief Encounter – call 0808 802 0111 Monday to Friday, 9am to 9pm, or email [contact@griefencounter.org.uk](mailto:contact@griefencounter.org.uk)
- Hope Again – call 0808 808 1677 Monday to Friday, 9.30am to 5pm, or email [hopeagain@cruse.org.uk](mailto:hopeagain@cruse.org.uk)
- Winston's Wish – call 0808 802 0021 Monday to Friday, 9am to 5pm, or email [info@winstonswish.org](mailto:info@winstonswish.org)
- Young Minds – [www.youngminds.org.uk](http://www.youngminds.org.uk)
- Young Minds Crisis Messenger: Text YM to 85258
- Childline – [www.childline.org.uk](http://www.childline.org.uk) Phone: 0800 1111
- Samaritans – [www.Samaritans.org](http://www.Samaritans.org) Phone: 116 123
- Young Minds Matters – Text 07480635723
- Kooth – Kooth.com
- TIC+ - online text chat – 07977334433
- Self-harm Helpline Rethink Gloucestershire – webchat: [www.gloucestershireselfharm.org](http://www.gloucestershireselfharm.org) Text: 07537410022
- Phone: 0808 801060

Year 8 Unit 1 - Computer systems	
Lesson 1	Lesson 2
<p><b>What is a general purpose computing system?</b> The purpose of a general-purpose computer is to execute programs that operate on data.</p> <p><b>Define "program" in terms of instructions, operations and data.</b> A program is a sequence of instructions that specify operations that are to be performed on data</p> <p><b>What is the difference between a general-purpose computing system and a purpose-built device?</b> Special-purpose computers are designed for one specific task or class of tasks and wouldn't be able to perform general computing tasks. For example, a router is a special-purpose computer designed to move data around a network, while a general-purpose computer can be used for this task, as well as many others.</p>	<p><b>Describe the hardware components used in computing systems and how they work together in order to execute programs</b> Computer hardware and software work together to process information in the following way: The hardware consists of the physical components of the computer, such as the processor (CPU), memory (RAM), hard drive, and other peripherals. The software consists of the instructions that tell the hardware what to do.</p> <p><b>Explain how all computing systems, regardless of form, are similar in structure ('architecture')</b> All computing systems, regardless of form or capabilities, make use of the same components: a processor, memory, storage, input and output devices, and communication components.</p>
<p><b>Lesson 3</b></p> <p><b>Explore how the processor, main memory, and storage interact to execute programs in real scenarios</b> Processors are responsible for executing instructions that make up computer programs. The instructions are stored in memory, and the processor fetches them from memory, one at a time, and executes them. Memory stores the program code and data that the processor needs to execute the program.</p> <p><b>Define what an operating system is, and explain its role in controlling program execution.</b> An Operating System (OS) allows interaction between the computer user and computer hardware. It also controls the execution of programs. Its role includes file, memory and process management, handling input and output and controlling devices.</p>	<p><b>Keywords</b></p> <p><b>The Antikythera mechanism:</b> complex geared mechanism that could predict solar eclipses, as well as the position of the moon and known planets.</p> <p><b>General purpose computer:</b> A device that executes programs that operate on data.</p> <p><b>Software:</b> Any program or app that can be used by a computer.</p> <p><b>Operating system:</b> A piece of software that controls the operation of a computer, the software that the computer runs and data that the computer uses.</p> <p><b>Hardware:</b> The physical components that a computer is made of.</p> <p><b>Processor:</b> The processor is the component that executes program instructions.</p> <p>An instruction may: Perform arithmetic or logic operations on data Perform input/output of data Control program flow</p>

<p>Lesson 4</p>	<p><b>What are NOT, AND, and OR logical operators.</b> The logical operators *AND and *OR specify the relationship between operands in a logical expression. The logical operator *NOT is used to negate logical variables or constants. <b>Explain what logic gates are.</b> A logic gate is a device that acts as a building block for digital circuits. They perform basic logical functions that are fundamental to digital circuits. <b>Describe how binary can be used to represent logic gate operations.</b> Most logic gates have two inputs and one output, and they are based on Boolean algebra. At any given moment, every terminal is in one of the two binary conditions: true or false. False represents 0, and true represents 1.</p>	<p><b>Memory:</b> The main memory is the component that stores the programs and data currently in use. Memory is volatile: its contents are lost when the power is off. <b>Storage:</b> The storage (secondary memory) is the set of components that stores programs and data. Storage is persistent: it retains its contents when the power is off. <b>Operating system:</b> The operating system is a set of programs that controls the operation* of a computing system.</p>
<p>Lesson 5</p>	<p><b>What is 'artificial intelligence' and 'machine learning'?</b> Artificial intelligence is the simulation of human intelligence processes by machines, especially computer systems. Specific applications of AI include expert systems, natural language processing, speech recognition and machine vision. Machine learning happens when computers have access to information. Over time, this lets them learn how to make decisions without a human telling it what to do. <b>What are the steps involved in training machines to perform tasks?</b> Step 1: Data Acquisition. The first step in the machine learning process is to get the data. ... Step 2: Data Cleaning. All real-world data is often unorganised, redundant, or has missing elements. ... Step 3: Model Training. ... Step 4: Model Testing. ... Step 5: Deployment. <b>How does machine learning differ from traditional programming?</b> Machine learning does not eliminate programming. It replaces the problem of programming a machine to perform a task with two separate problems: programming the machine to learn, and providing it with the necessary training <b>Describe one moral dilemma associated with the use of artificial intelligence.</b> Who is responsible in an accident? (Accountability) How can decisions be explained? (Transparency) How can we guarantee that machine training does not lead to discrimination? (Bias)</p>	<p><b>Boolean logic:</b> There are three fundamental logical operations: not (inversion) and (conjunction) or (disjunction) <b>Machine learning:</b> Programming computers to learn from experience should eventually eliminate the need for much of this detailed programming effort. <b>Artificial intelligence:</b> Any machine that performs tasks that typically require intelligence in humans <b>Source code:</b> The computer code that has been written to create an app or program.</p>

	<p>How will humans handle lower demand for labour? How will the benefits of AI be fairly distributed?</p>	
Lesson 6	<p><b>What are the implications of sharing program code?</b> The creators of a program can choose to provide access to its source code: anyone can 'see inside' the program to understand how it works, check for errors, suggest improvements, and 'remix' it. This is called 'free' (as in 'freedom'), 'libre', or 'open source' software.</p>	