

Year 7

Knowledge Organiser

January - April 2025

AMBITION, CONFIDENCE, CREATIVITY,
RESPECT, DETERMINATION

Proud to be
part of the
 GREENSHAW
LEARNING TRUST



Why do we have knowledge organisers?

Knowledge organisers are a collation of the basic essential knowledge for success in each subject area that will underpin your learning for the term.

They are designed to provide the information you will need to be committing to your long term memory through recall exercises in Low Stakes Quizzing.

How do we use knowledge organisers?

You should be using these KOs to create your homework quizzes so that you are practising retrieving information.

1. You can do this by testing yourself on the definition of key terms (both recalling the key term and then swapping to recall the definition), practice labelling diagrams, retrieves reasons and justifications for the main learning points.
2. They can also be used for 'memory dumps' where you try to recall as much of the information about a topic as possible and then use the KP to fill in the gaps.
3. They can also be used in class to assist with retrieval of the core knowledge needed for each subject.

You should have these with you at all times in school and out on your desk in all lessons.

If you lose your KO or it becomes too dishevelled, please purchase a new one from the Head of Year or the School Office.

<u>Contents</u>	
English	Page 1
Mathematics	Page 3
Science	Page 6
History	Page 21
Geography	Page 26
French	Page 31
Spanish	Page 34
RE	Page 37
DT:Food	Page 39
Art	Page 41
Drama	Page 43
PCSHE	Page 44
Computer science	Page 46

AMBITION, CONFIDENCE, CREATIVITY,
RESPECT, DETERMINATION

Proud to be
part of the
GREENSHAW
LEARNING TRUST

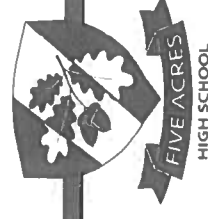

Year 7 English Term 2 Rowan Leader of the Deer Kin Journeys Knowledge Organiser

Key subject terminology

Adjective : Used to modify a noun or complement a verb.

Noun: Name of a person, place or thing.

Adverb: A word that describes a verb.

Adverbial phrases : A group of words that add to the meaning of a verb, adjective or adverb.

Characterisation: making a character seem three dimensional.

Verb: Word which determines an action E.g. run.

Pronoun: words instead of a noun – I, we, you, she.

Preposition: Tells you where or when something is.

Punctuation

Semi-colons: links two independent clauses that are closely related. Can also be used in a list.

Speech marks: “ ” punctuation to show someone speech.

Apostrophe: punctuation to show omission or possession.

Writers literary methods

Simile: Compares two things with ‘like’ or ‘as’.

Metaphor: describes a person or object as something else

Personification: Gives human characteristics to something non-human.

Pathetic Fallacy: Uses the weather or nature to portray a feeling/mood.

Plot device: an element in the story which enables the plot to move forwards.

Zoomorphism: makes something non animal seem animal.

Key Context for Rowan Leader of the Deer

Written by Sarah Green

- Local novelist based in Tewkesbury
- From a teaching background
- Written to include natural elements found locally to us!
- Written in the tradition of Watership Down

Key Themes in Rowan and the Deerfolk

- **Coming of age**: Rowan starts the novel as a yearling, filled with doubt. By facing his fears he develops the skills necessary to navigate his family away from danger.
- **Loyalty and respect**: This is explored through the moral obligation of the characters and what they should do to preserve the unity and cohesion of the group.
- **Power**: The story revolves around Rowan’s journey and his conflict with Twayblade.
- **Bullying**: Rowan faces a dangerous struggle with Twayblade, who is his arch nemesis and rival.
- **Conservation**: What happens to animals when man invades natural territories and can they live side by side?
- **Society and rules**: How we choose to live our lives impacts on the lives of others and often there are consequences from actions.
- **Nature**: The book forces us to consider the other species which inhabit where we live.
- **Freedom**: the right to have choice and agency over our lives.

Key Vocabulary

Anxiety – a state of constant uneasiness and fear.

Antagonist – a character that causes conflict or struggle against others.

Barbarity – savageness or cruelty.

Criminality – the condition of being a criminal.

Degenerate – to decline from a moral standard.

Duplicity – double-dealing; insincerity.

Duty – what you are bound to do.

Exploitation – the act of using someone or something for selfish purposes.

Eponymous hero – protagonist who is named in the title.

Feral – being in a wild state.

Heroism – acts of courage or bravery.

Kin - family

Morality – the principles of right and wrong.

Misconduct – unacceptable behaviour.

Nefarious – wicked or criminal actions.

Paradox – contrary to expectation.

Protagonist – one of the main characters.

Respectability – being respectable and of good character.

Restraint – holding back or keeping under control.

Untrustworthy – cannot be trusted.

Utopia: A place of perfection

Vengeance –punishment handed out to address a crime.

Key characters

- Rowan:** the protagonist who leads his kin on their epic journey.
- One:** the antagonist of the narrative who sees Rowan and his kin as prey.
- The Kindred:** Rudd, Siskin, Juniper and Bracken who are Rowan's peers and fellow yearlings.
- Twayblade:** Rowan's nemesis within the kin, a bully who seeks to dominate Rowan and prevent him from his calling.
- Dern:** leader of the Big Crests – another breed of deer
- Sirrah Tor:** Rowan's father, and leader of the Deer Kin in the opening of the novel.
- Mother (Willow):** Rowan's mother and doe of Sirrah Tor's herd.
- Hawthorn, Old Buck of Stones:**
- Skylar:** The beautiful silver deer who leads Rowan and the Deer Kin to the island
- The Duir:** the mystical spiritual power revered by the Deer Kin embodied in the form of a sacred tree.
- Key settings**
- May Hill:** A landmark hill on the edge of The Forest of Dean
- The Forest of Dean:** Ancient woodland of oak and beech, bordered by the River Severn, approximately 26,000 acres.
- Severn Tunnel Junction:** A railway tunnel over 4 miles long which stretches underneath the River Severn. Opened in 1886 to shorten the length of times of trains from Wales to London
- Bristol:** The Largest city in the South West of England.
- Glastonbury:** located on the other side of the river, Glastonbury Tor is a prominent hill which overlooks the Isle of Avalon, Glastonbury and Somerset
- Dartmoor:** a mixture of open moorland and woodland, Dartmoor is classed as National Park and has a rich variety of natural flora and fauna as well as rare wildlife.
- Looe Island:** a nature reserve which is situated off the coast of Cornwall

Persuasive techniques/ rhetorical devices:

- Alliteration:** the occurrence of the same letter or sound at the beginning of words.
- Facts:** things which can be proven true.
- Opinion:** ideas which cannot be proven true
- Rhetorical questions:** questions designed to make the reader think
- Emotive language:** Words used to create an emotion in the reader.
- Statistics:** numerical facts, often in the form of a percentage or fraction
- Tripling:** an idea, word or expression repeated three times for emphasis
- Tricolon:** Three parallel clauses, phrases, or words.
- Isocolon:** Two or more clauses that share the same structure.
- Direct Address:** The writer speaks directly to the listener.
- Anaphora:** Repetition of words at the start of a clause or sentence.
- Statistics: numerical fact
- Epistrophe:** repetition at the end of a sentence
- Emphatic/ exclamatory statements** using an exclamation mark
- Direct address:** Use of we/us to create unity, you to sound accusatory and they/them to create a divide.
- Hyperbole:** exaggeration for effect.
- Anecdotal evidence:** a personal story which gives your idea or theory credibility.
- Aristotelian triangle:** logos, pathos and ethos
- Headline:** A catchy phrase to inform the reader of story content.
- Strapline:** Additional information underneath the headline

Inverted Pyramid News Writing

Style

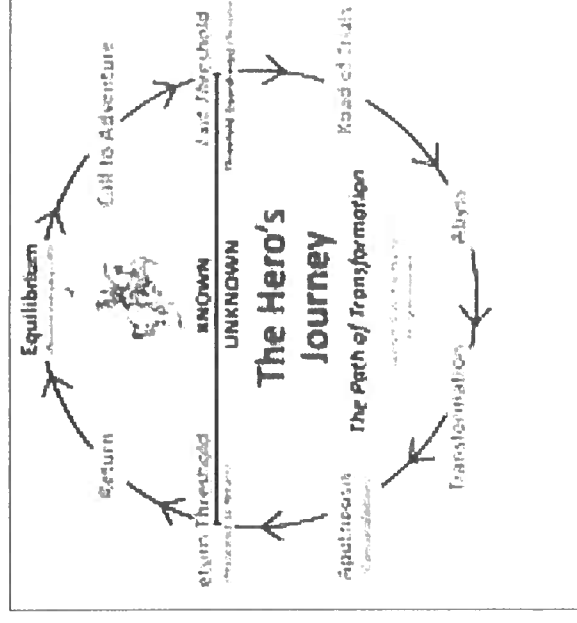
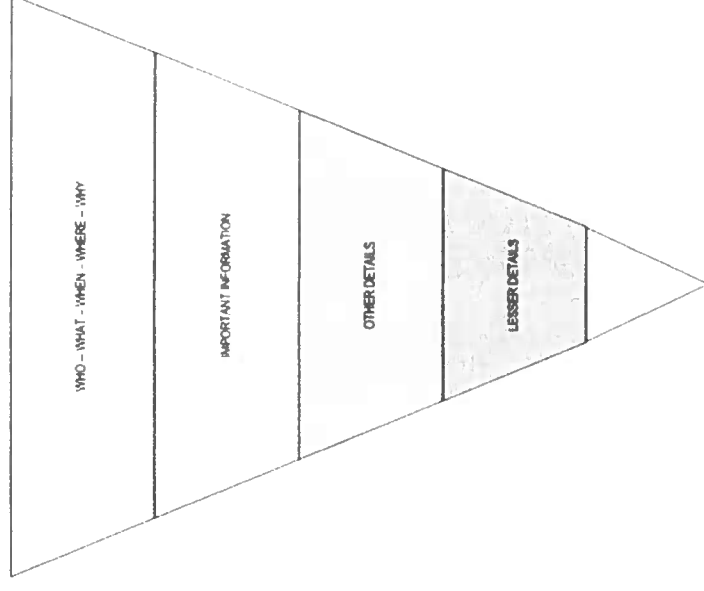

Line and shape properties

Topics

- Line properties (M814)
- Shape properties (M276)
- Symmetry (M523)

Keywords

Parallel - lines in the same direction that never meet.

Perpendicular - lines meeting in a 90 degree/right angle.

Equilateral triangle - has equal sides and equal angles.

Isosceles triangle - has two equal sides and two equal angles.

Scalene triangle - has all different length sides and different size angles.

Quadrilateral - 4 sided shape.

Regular polygon - a shape with all sides the same length.

Irregular polygon - a shape with different length sides.

Line of symmetry - a line that divides a shape or an object into two identical parts.

Vertices - corners of a shape, where two or more edges meet.

Perimeter

Topics

- Finding perimeters using grids (M920)
- Finding the perimeter of rectangles and simple shapes (M635)
- Finding the perimeter of compound shapes (M690)

Building Blocks

- Adding (M928, M429)
- Line properties (M814)
- Shape properties (M276)

Keywords

Perimeter - the distance around the edge of a shape.

Compound shape - a shape made from 2 or more other shapes.

Area

Topics

- Finding areas using grids (M900)
- Finding the area of rectangles (M390)
- Finding the area of compound shapes (M269)
- Finding the area of triangles (M610)
- Finding the area of compound shapes containing triangles (M996)

Building Blocks

- Multiplying (M187, M803)
- Line properties (M814)
- Shape properties (M276)

Keywords

Area - the space inside a shape.

Area of a rectangle - length x width.

Area of a triangle - $\frac{1}{2}$ x base x perpendicular height.

Coordinates and shapes

Topics

- Reading and plotting coordinates (M618)
- Solving shape problems involving coordinates (M230)

Building Blocks

- Shape properties (M276)

Keywords

Quadrant - four quarters of the coordinate system.

Coordinate - a point on the coordinate system written as (x , y).

Axes - the x axis is horizontal and the y axis is vertical.

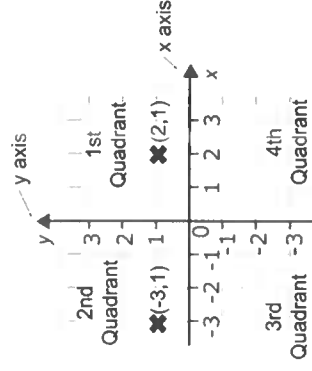

Factors and multiples

Topics

- Finding the lowest common multiple (M227)
- Finding factors and using divisibility tests (M823)
- Finding the highest common factor (M698)

Building Blocks

- Times tables
- Dividing numbers into equal groups (M462)
- Using a written method to divide integers (M354)

Keywords

Multiples - times tables (e.g. multiples of 3: 3, 6, 9, 12, 15...).

LCM - lowest common multiple.

Factor pairs - numbers that multiply to make another number (e.g. factors of 14: 1, 2, 7, 14).

HCF - highest common factor.

Primes

Topics

- Finding prime numbers (M322)
- Prime factor decomposition (M108)

Building Blocks

- Times tables
- Finding factors and using divisibility tests (M823)
- Dividing numbers into equal groups (M462)

Keywords

Prime number- number that is only divisible by 1 and itself (2, 3, 5, 7, 11, 13 ...).

Product - multiply.

Product of prime factors (prime decomposition) - write a number as its prime factors multiplied together (e.g. $12 = 2^2 \times 3$).

Index form - collecting together numbers that are multiplied together (e.g. $4 \times 4 \times 4 = 4^3$).

Writing and comparing fractions

Topics

- Finding fractions of shapes (M158)
- Constructing fractions (M939)
- Finding equivalent fractions (M410)
- Simplifying fractions (M671)
- Ordering fractions (M335)
- Converting between mixed numbers and improper fractions (M601)

Building Blocks

- Finding the lowest common multiple (M227)
- Finding the highest common factor (M698)

Keywords

Fraction - a part of a whole. Made up of two parts; numerator and a denominator.

Unit fraction - a fraction that has numerator = 1.

Simplify - make the numerator and denominator as small as possible by dividing by common factors.

Ascending - increasing in size.

Descending - decreasing in size.

Mixed number - a number larger than 1 written as a whole number and a fraction (e.g. $1\frac{1}{2}$).

Improper fraction - a number larger than 1 written as a single fraction (e.g. $\frac{7}{5}$).

Adding and subtracting fractions

Topics

- Adding and subtracting fractions (M835)
- Adding and subtracting mixed numbers (M931)

Building Blocks

- Finding the lowest common multiple (M227)
- Finding the highest common factor (M698)
- Finding equivalent fractions (M410)
- Simplifying fractions (M671)
- Converting between mixed numbers and improper fractions (M601)

Keywords

Integer - whole-valued positive or negative number or 0.

Sum - add.

Single brackets

Topics

- Using the distributive law (M637)
- Expanding single brackets (M237)
- Expanding single brackets and simplifying expressions (M792)
- Factorising into one bracket (M100)

Building Blocks

- Algebraic notation (M813)
- Simplifying expressions containing a single variable (M795)
- Finding the highest common factor (M698)

Keywords

Distributive law - $a(b+c) = ab + ac$ (Multiplying out brackets).

Expand - remove bracket by multiplying.

Variable - a quantity that can be changed and is not a fixed constant.

Constant - a value that stays the same (e.g. +4).

Term - each part of an expression added or subtracted together (e.g. $x + 5$ has 2 terms, $5y + 3x + 7$ has 3 terms).

Factorise - identify the highest common factor from an algebraic expression, place outside brackets and make it equivalent to the original expression.

Year 7 Biology Knowledge Organiser – Interdependence

Box 1: Ecosystems

An ecosystem is the interaction between the living things and non-living things in an environment.

- Organisms within an ecosystem rely on each other for food, shelter, seed dispersal etc.
- Animals compete with each other for food, mates and territory.
- Plants within a habitat compete for light, space, water and mineral ions from the soil.

Box 2: Feeding Relationships (food chains and food webs)

A **food chain** shows the transfer of energy between organisms in an ecosystem: e.g. lettuce → caterpillar → bird

Arrows show the transfer of energy from one organism to another.

A **food web** is used to show the feeding relationships within an ecosystem and is made of multiple food chains.

Energy for all food chains and food webs comes from the Sun.

All food chains and webs start with a producer. Consumers are animals that eat to get energy.

A top consumer is an organism that isn't eaten by any other, e.g. lion.

Populations of organisms within an ecosystem can be affected by numbers of other organisms within the ecosystem or by human behaviours such as hunting or poisoning (e.g. DDT).

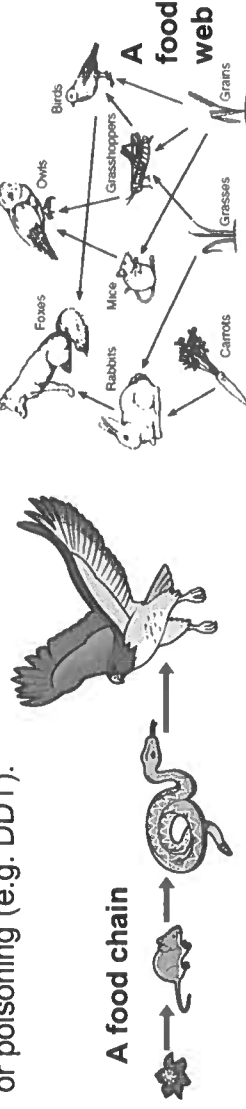

Box 3: Classification

Organisms are classified based on their similarities and differences. Classification allows organisms to be identified and enables scientists to identify new species.

Carl Linnaeus started the classification system as we know it today. Organisms are assigned a kingdom, phylum, class, order, family, genus, species.

When organisms are part of the same species they can successfully reproduce. Each species is given a Latin name.

Key Terms	Definitions
Organism	A living thing
Habitat	Area in which organisms live
Ecosystem	Interaction of a community of living organisms with the non-living parts of their environment
Predator	Organism that hunts and kills its food
Prey	Organism that is eaten by another organism
Scavenger	Eats food that has been killed by a different organism
Carnivore	Organism that only eats meat
Herbivore	Organism that only eats plants
Omnivore	Organism that eats plants and animals
Producer	Organism that produces its own food, e.g. a plant
Consumer	Organism that eats food to gain energy and biomass, e.g. an animal
Food chain/web	Diagrams to show the transfer of energy in an ecosystem
Classification	Grouping organisms based on their similarities and differences
Species	Organisms that are able to successfully reproduce
Adaptation	Feature or behaviour that increases the chances of survival: Structural (feature of an organism's body), Behaviour (response made by an organism), Functional (body process)

Year 7 Biology Knowledge Organiser – Interdependence

Box 4: Adaptation	Animal in cold climates	Animal in dry climates	Plants in Dry Climates (cactus)
Behaviour	Penguins huddle together to conserve heat	Often nocturnal when temperature is cooler	n/a
Structural	Thick fur and thick layer of body fat. Small SA : Vol ratio	Thin limbs giving a large SA : Vol ratio. Loses heat easily	Wide shallow or narrow deep roots No leaves and waxy cuticle
Functional	Hibernation: rate of reactions decreases for hibernation	E.g. Camel produces little urine/sweat to conserve water	Photosynthesis in stem as no leaves

Box 6: Adaptations of predator and prey animals

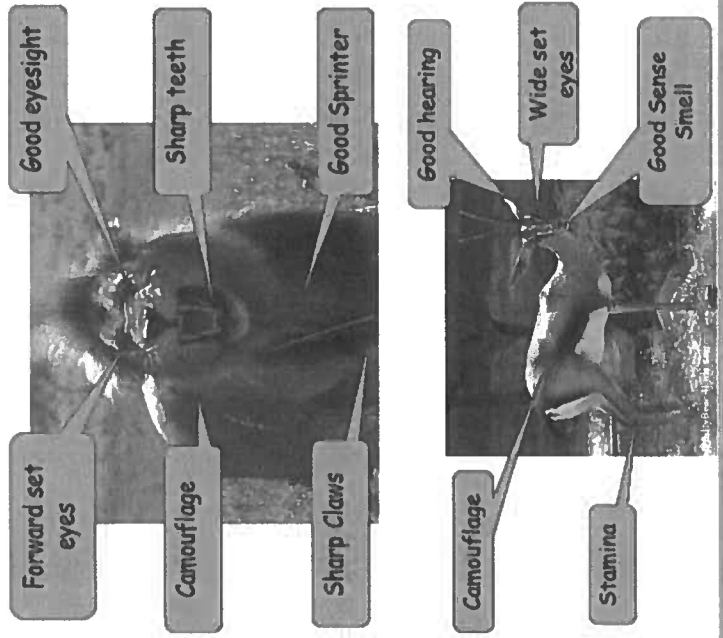

Box 7: Adaptations of animals in cold regions

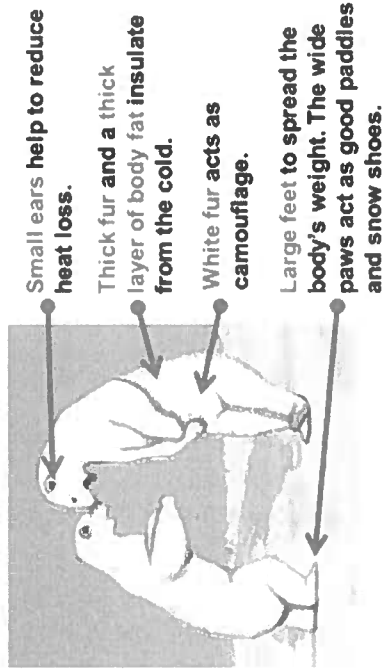

Small surface area:volume ratio

Box 9: Surface area : Volume ratio
Surface area:volume ratio refers to how large the skin (or surface) of the animal is compared to the body size (or volume). A large ratio is when there is a large difference in the numbers in the ratio (e.g. 6:1)

Box 5: Adaptations of desert plants

PLANT ADAPTATIONS

- Structural:**
 - Shallow roots to soak up water over a large area
 - Deep roots to get to water stored underground
 - No leaves to reduce water loss
- Functional:**
 - Photosynthesis in stems because no leaves
 - Flowers open at night when cooler

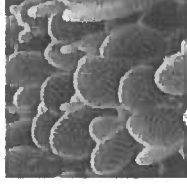

Box 8: Adaptations of Animals and Plants in Dry Climates

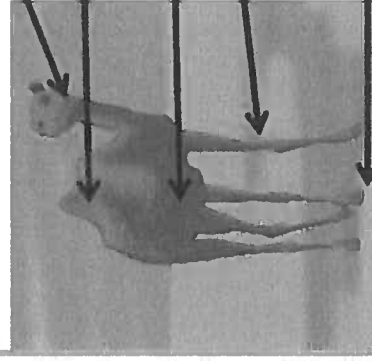

Large surface area:volume ratio

Year 7 Biology Knowledge Organiser Organisation 1 – Organ Systems page 1

Box 1 – Hierarchy All living things are made from cells. Cells are the smallest units of life. Cells work together in tissues, organs, and organ systems.

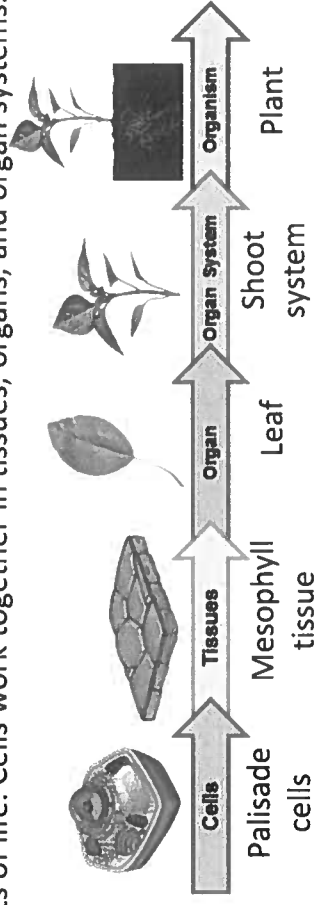
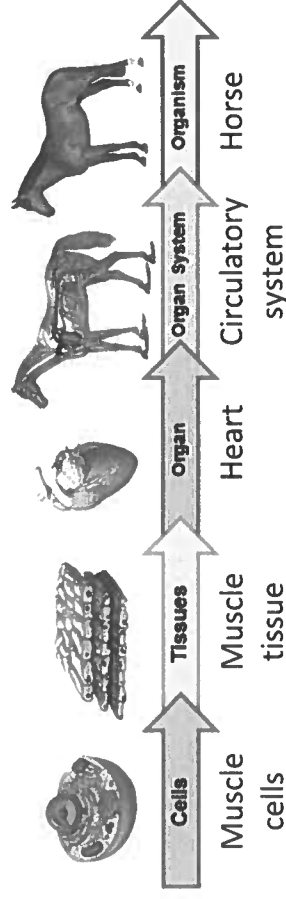

Box 2 – The digestive system

Food is digested in the digestive system, this is an organ system.

Digestion means that food is broken down and changed into a form that can be absorbed.

When food is eaten it passes through the organs of the digestive system as follows:

Mouth → Oesophagus → Stomach → Small intestine → Large intestine → Anus

Mechanical digestion

- The mouth has teeth that mechanically digest the food
- The oesophagus is a muscular tube that pushes the food into the stomach.
- The stomach churns the food up.

Chemical digestion

- The mouth has salivary glands that releases enzymes to break food down.
- The stomach adds acid and enzymes to break the food down.
- The small intestine is the main place chemical digestion occurs. Enzymes are released and break down food. The food molecules are then absorbed through the walls of the intestine into the blood.

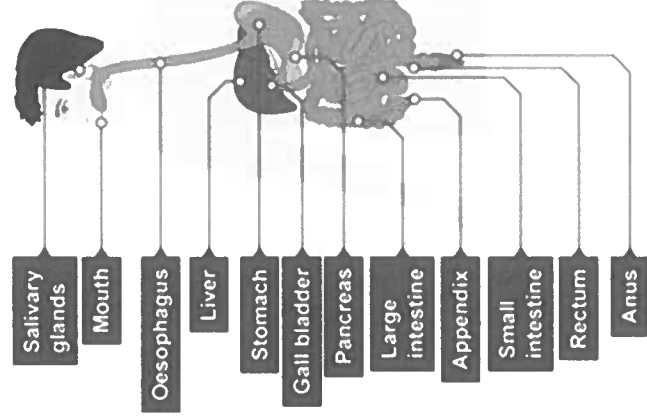

Key Terms	Definitions
Cell	The smallest unit of life, all living things are made of cells
Tissue	A group of cells working together to perform a particular function
Organ	A group of tissues working together to perform a particular function
Organ system	A group of organs working together to perform a particular function
Organism	An individual animal, plant, or single-celled life form
Digestive System	The organ system that breaks down food into small pieces that can be absorbed
Mechanical Digestion	When large pieces of food are broken down into smaller ones (e.g. by chewing)
Chemical Digestion	When food is broken down into small chemicals that can be absorbed, using enzymes
Enzymes	Chemicals that break down large pieces of food into smaller pieces during chemical digestion

Year 7 Biology Knowledge Organiser Organisation 1 – Organ Systems page 2

Box 3 – The skeletal system

The skeletal system is made of bones that are joined together at joints. It is sometimes called the skeleton.

The skeletal system has 4 main functions:

- To provide support
- To allow movement (enabled by joints, and working with the muscular system)
- To protect organs
- To produce blood cells in bone marrow

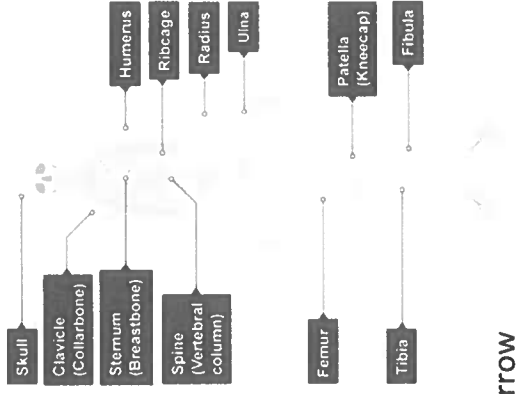

Key Terms

Key Terms	Definitions
Connective Tissue	Tissue that connects or supports other tissues or organs e.g. ligaments, cartilage or tendons
Ligaments	Stabilises joints, connects bones to other bones
Cartilage	Connective tissue which is found at the end of bones to cover and protect them
Tendons	Connects muscles to the skeletal system
Antagonistic Pairs	Pairs of muscles where each opposes the movement of the other e.g. biceps and triceps
Stimulus	A specific event which leads to a reaction
Central Nervous System (CNS)	The brain and the spinal cord

Box 4 – Joints

Joints are the point at which two bones of the skeleton fit together.

The bones at a joint are held together by connective tissues (ligaments, cartilage and tendons). Joints often allow movement, so also have synovial fluid, which provides lubrication within the joint.

There are different types of joints, for example:

- Ball and socket joints (in your hip or shoulder)
- Pivot joints (let you turn your neck or rotate your forearm)
- Hinge joints (in your elbow or knee)
- Fixed joints (found in your skull)

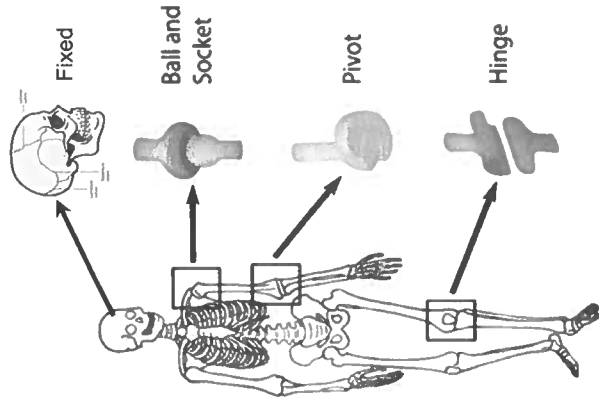

Box 5 – Movement

The skeletal system and muscular system work together to enable movement. During a movement, a muscle contracts and pulls on a bone, which applies a force and causes the bone to move. Muscles are only able to contract and get shorter, so muscles work in antagonistic muscle pairs.

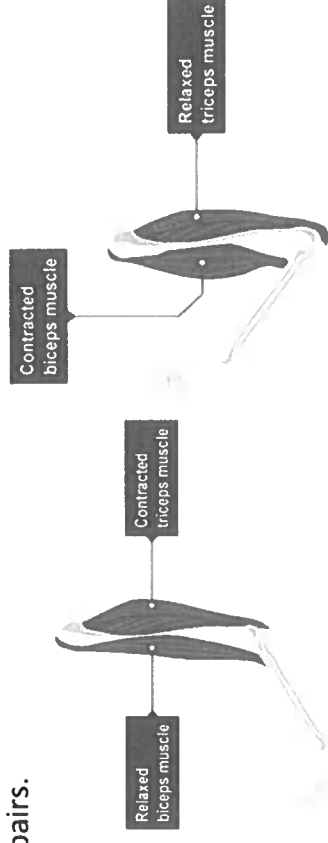

Muscles are controlled by nerves. Nerve cells carry electrical signals to muscles from the central nervous system to produce a response to the stimulus. Some responses are automatic (reflexes) and others are conscious.

Year 7 Chemistry Knowledge Organiser - The Atom

Box 1 - The structure of the atom

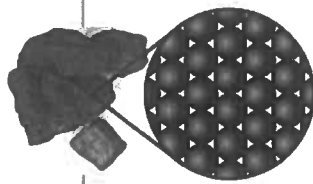

Substances are made up of atoms

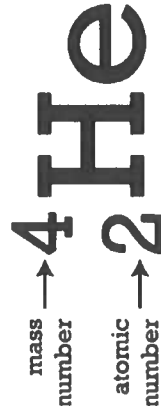
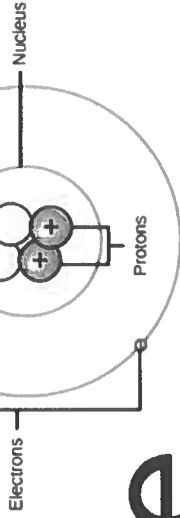

Particle	Location	Charge	Mass
Proton	Nucleus	1+	1
Neutron	Nucleus	No Charge	1
Electron	Energy Level	1-	1/2000 th Mass of proton

Box 2 - The development of the atomic model – our understanding of the structure of the atom has changed over time. Scientists relied on experimental evidence, deduction and technological developments to identify the components of the atom.

When	Who	Proposed Model
440BC	Democritus	All matter is made up of atoms that were indivisible
1803	John Dalton	All matter is made up of indivisible spheres called atoms. He stated that substances made of the same type of atom were elemental and described different type of atom chemically bonded as compounds.
1904	JJ Thomson	Discovered the electron . He proposed a model of the atom, with the sphere being made up of positively charged matter with negatively charged electrons dotted through it – this modelled was described as the plum pudding model .
1909	Rutherford	Identified the nucleus of the atom has a positive charge and that the mass of the atom is concentrated at the centre. This evidence disproved the plum pudding model and led to the nuclear model .
1916	Bohr	Identified that electrons orbit the nucleus in energy levels/shells .
1920	Rutherford	Identified the existence of the proton , the positive particle in the nucleus.
1932	Chadwick	Identified the neutron in the nucleus.

Key Terms	Definitions
Atom	Atoms are the smallest particles of an element that still have the properties of the element
Energy Level/shell	An area on the outside of the atom where electrons are found. Atoms can have many energy levels.
Nucleus	The central area of an atom where protons and neutrons are located, this part of the atom contains the mass (this mass is due to the neutrons and protons within nucleus)
Electron	A particle, found in the energy level, it has a negative charge and a negligible mass (1/2000 th of the mass of a proton).
Proton	A particle found in the nucleus of the atom. It has a positive charge and a relative mass of 1.
Neutron	A particle found in the nucleus. It has a relative mass of 1 and no charge.
Atomic number	Shown for each element on the periodic table, this number states the number of protons in the nucleus (proton number)
Atomic Mass	The sum of the protons and neutrons in the nucleus, (number of protons and neutrons added together).
Indivisible	Term used to describe that an object cannot be broken down into smaller parts.
Positive	A type of charge indicated by the symbol +. A positively charged object is attracted to an object with a negative charge, however it is repelled by an object with a positive charge.
Negative	A type of charge indicated by the symbol -. A negatively charged object is attracted to an object with a positive charge, however it is repelled by an object with a negative charge.
Plum Pudding	A model proposed by JJ Thomson which describes the atom as a sphere of positive charge which contained negative electrons dispersed through the positive charge.

Year 7 Biology Knowledge Organiser - The Cell

Use a microscope to produce an image of a cell in focus.

Box 1 - Parts of a microscope

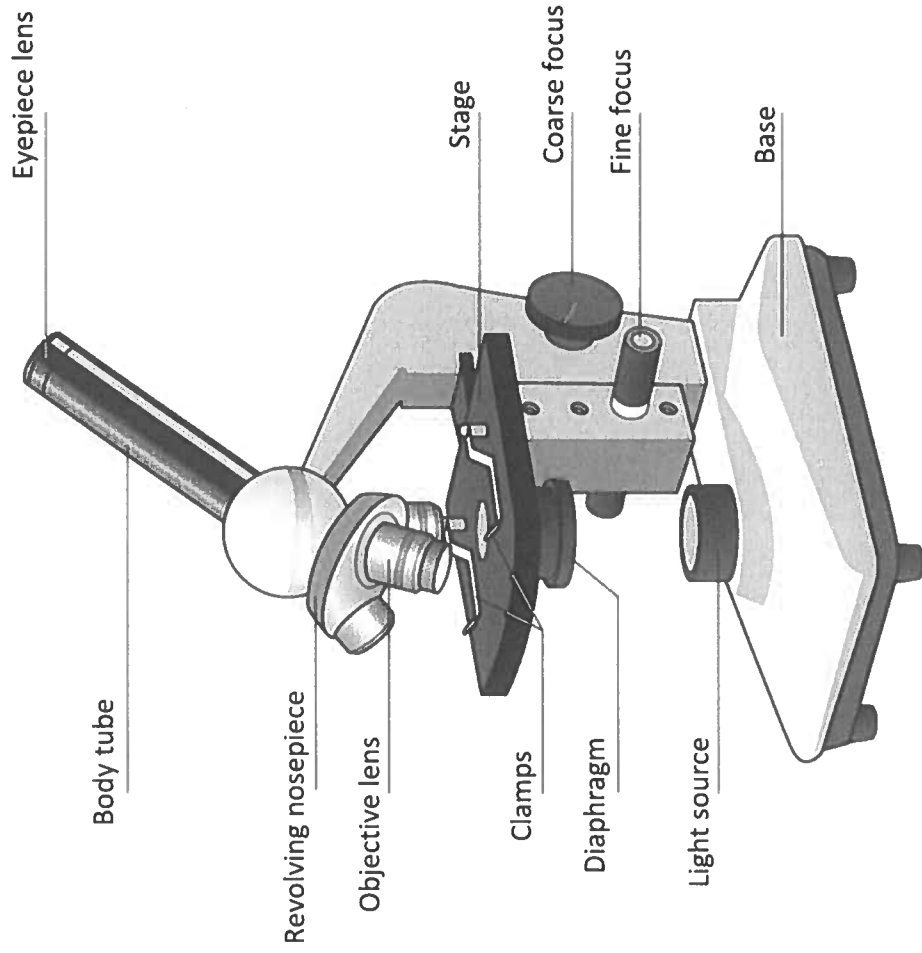

Key Terms	Function
Stage	Area where specimen is placed
Clamps	Hold the specimen still whilst it is being viewed
Light source	Illuminates the specimen
Objective lens	Magnifies the image of the specimen
Eyepiece lens	Magnifies the image of the specimen
Course/fine focus	Used to focus the specimen so it can be seen clearly
Revolving nosepiece	Holds 2 or more objective lenses

Box 2 - Magnification

We can use the following equation to calculate the magnification of an object viewed through a microscope:

$$\text{magnification} = \frac{\text{image size}}{\text{actual size}}$$

Box 3 - Using a microscope

To view an object down the microscope we can use the following steps:

1. Plug in the microscope and turn on the power.
2. Rotate the objectives and select the lowest power (shortest) one.
3. Place the specimen to be viewed on the stage and clamp in place.
4. Adjust the coarse focus until the specimen comes into view.
5. Adjust the fine focus until the specimen becomes clear.
6. To view the specimen in more detail repeat the process using a higher power objective.

Year 7 Biology Knowledge Organiser - The Cell

Label plant and animal cells; state the function of the organelles and compare plant and animal cells.

Box 4 - Cells

Cells are the smallest units of life. Everything alive is made of cells.

Animal Cell

Plant and Animal Cells share these common features

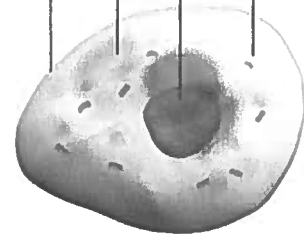

Plant Cell

Plant Cells contain these extra features

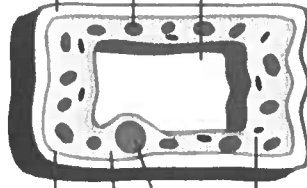

Animal and plant cells are similar because they both have a nucleus, cell membrane, mitochondria and cytoplasm. Plant cells are different because they have a cell wall, vacuole and chloroplasts.

Box 5 - Preparing a microscope slide

To prepare a slide to view onion cells we can use the following steps:

1. Cut open an onion.
2. Use forceps to peel a thin layer from the inside.
3. Spread out the layer on a microscope slide.
4. Add a drop of iodine solution to the layer.
5. Carefully place a cover slip over the layer.

Key Terms	Definition
Cell wall	Made of cellulose, which supports the cell
Cell membrane	Controls movement of substances into and out of the cell
Cytoplasm	Jelly-like substance, where chemical reactions happen
Nucleus	Contains genetic information and controls what happens inside the cell
Vacuole	Contains a liquid called cell sap, which keeps the cell firm
Mitochondria	Where most respiration reactions happen (glucose + oxygen → carbon dioxide + water)
Chloroplast	Where photosynthesis happens (carbon dioxide + water → glucose + oxygen)

Box 6 - Specialised cells

Specialised cells are found in multicellular organisms. Each specialised cell has a particular function within the organism.

Type of cell



Red blood cells

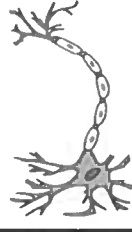

Nerve cells



Male reproductive cell (sperm cell)



Root hair cell



Leaf cell

Animal cells

Plant cells

Function

To carry oxygen

To carry nerve impulses to different parts of the body

To reach female cell and join with it

To absorb water and minerals

To absorb sunlight for photosynthesis

Special features

- Large surface area, for oxygen to pass through
- Contains haemoglobin, which joins with oxygen
- Contains no nucleus

- Long
- Connections at each end
- Can carry electrical signals

- Long tail for swimming
- Head for getting into the female cell

- Large surface area

- Large surface area
- Lots of chloroplasts

Year 7 Chemistry Knowledge Organiser – Elements and Compounds

Box 1 - Atoms, Elements and Compounds

Atoms are the smallest units of matter that have the properties of an element. All substances that exist are made of atoms. The arrangement of the atoms changes depending on whether the substance is a solid, a liquid or a gas.

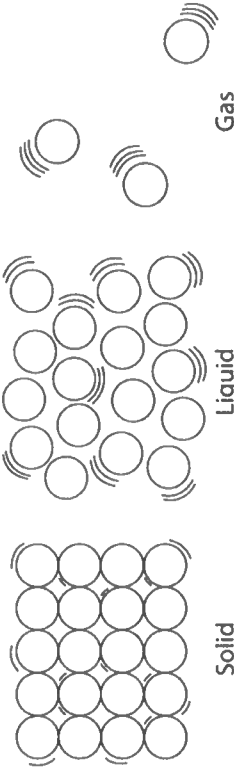

Elements are substances made of one type of atom. Each element found in the periodic table is made of a different type of atom. Most elements are either solid or gas at room temperature, only bromine and mercury are liquid at room temperature.

The diagram shows a solid element, such as sodium, carbon or copper.

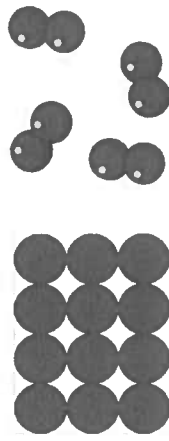

The diagram shows a gaseous element, such as oxygen, nitrogen or chlorine.

The atoms in the diagram are all the same colour and size, showing that they are the same type of element.

Compounds are substances made of two or more different elements chemically bonded together in fixed proportions.

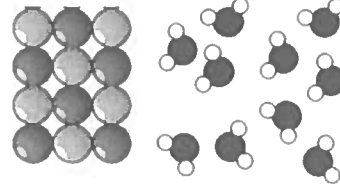

Both diagrams show compounds because the atoms are different colours and, on the lower diagram, different sizes. The upper diagram shows a solid compound. The lower diagram shows a gas. Each compound has the same number of each atom, eg water is always made of one atom of oxygen and two atoms of hydrogen: H₂O

Using circles to illustrate elements and compounds is an example of a **scientific model**. A model is useful as a way of understanding a concept, but it is a **simplification**.

→ This type of particle diagram has limitations: they don't show the movement of particles, the three-dimensional nature of matter, the correct relative sizes of the atoms, or the colour of

Key Terms	Definitions
Atom	Atoms are the smallest units of matter that have the properties of an element.
Element	<ul style="list-style-type: none"> - Elements are substances made of one type of atom. - Elements are the different types of atom found in the periodic table.
Compound	Compounds are substances made of two or more different elements chemically bonded together in fixed proportions.
Particle diagram	A diagram used to show that substances are made of particles. They illustrate the arrangement of particles, whether the substance is a solid, liquid or a gas, whether a substance is an element or a compound, the relative sizes of atoms,
Scientific model	A way of understanding a scientific concept that usually involves simplifying the concept. Simplifying a concept means scientific models have limitations.
Simplification	Explaining something complex in a simpler way. Sometimes, when an explanation is simplified it has limitations.
Limitation	<ul style="list-style-type: none"> - A weakness in an explanation/scientific model. - An area a scientific model can't explain.
Relative size (of atoms)	The size of something compared to something else (how big one atom is compared to another)

Year 7 Biology Knowledge Organiser - Organisation 2 - Reproduction - the process by which offspring are produced

Box 1 – Female reproductive system

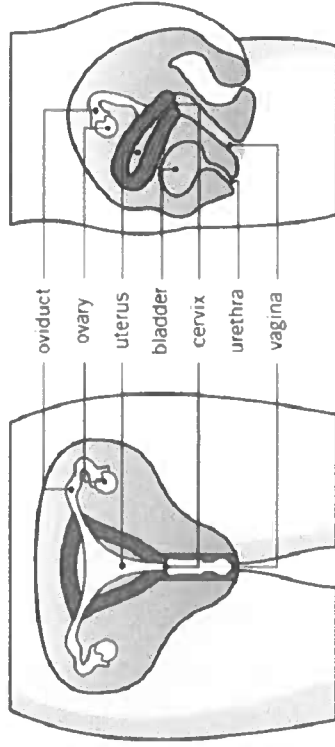

Box 2 – Male reproductive system

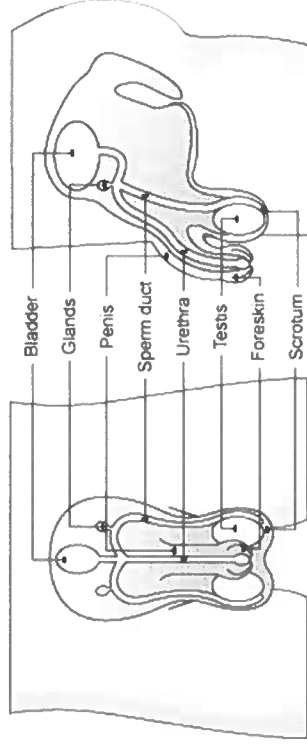

Box 3 – Puberty

During puberty reproductive hormones (chemicals made by the testes and ovaries) cause secondary sexual characteristics to develop, preparing an individual so they are ready to have offspring

1. Secondary sexual characteristics in males include growth of pubic hair, voice breaks, testes and penis gets bigger, shoulders widen, facial and body hair grows, testes start to make sex hormones and the body gets more muscular
2. Secondary sexual characteristics in females include breasts developing, pubic hair growing, ovaries start to release egg cell, periods start, hips widen, ovaries produce female sex hormone

Box 4 – Functions of organs in the reproductive systems.

Ovary	Organ where egg cells are produced in females.
Testicle	Organ where sperm cells are produced in males.
Penis	Organ which carries sperm out of the male
Scrotum	The skin that holds the testes
Urethra	The tube that carries either urine or semen out of the body through the penis
Vagina	Where the penis enters the female. This is also called the birth canal.
Oviduct, or fallopian tube	Carries an egg from the ovary to the uterus and is where fertilisation occurs.
Uterus/Womb	Where an embryo develops into a foetus and eventually into a baby.
Cervix	A muscular ring between the vagina and uterus. During birth it dilates to 10cm. It is sometimes called the neck of the womb.

Box 5 – Sex cells

Egg cells are female sex cells and sperm cells are male sex cells.

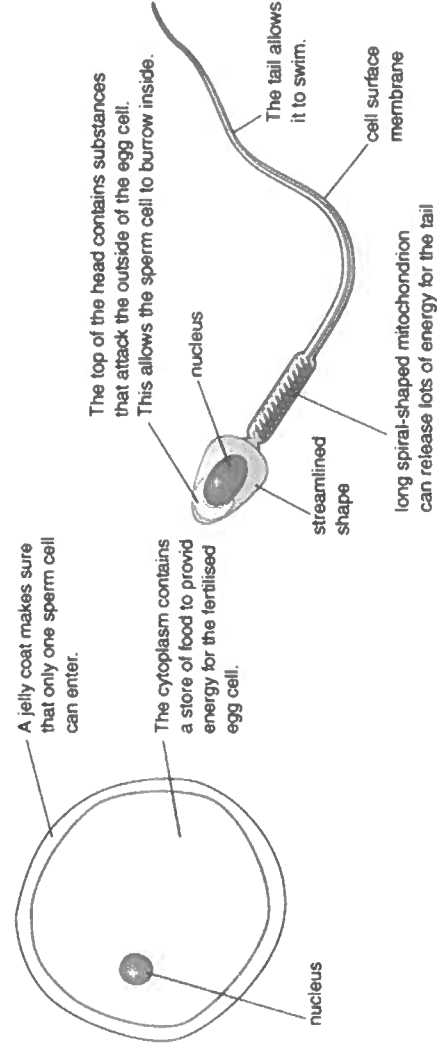

Year 7 Biology Knowledge Organiser - Organisation 2 - Reproduction - the process by which offspring are produced

Box 6 - Menstrual Cycle

The menstrual cycle is a **28 day cycle** where an egg cell is matured and released from an ovary and the uterus is prepared to support a fertilised egg cell during pregnancy. It is controlled by chemicals called hormones.

Days 1-5 – Uterus lining is lost (a period)

Days 6-13 – Uterus lining builds up and thickens to prepare for pregnancy and a new egg cell matures in the ovary.

Day 14 – Ovulation: a mature egg cell is released from an ovary.

Days 15-28 – Uterus lining stays thick and the egg cell travels down the oviduct to the uterus.

Box 7 – Fertilisation

Fertilisation usually occurs after sexual intercourse. Fertilisation is when a single sperm cell from a man joins with an egg cell from a woman. The nucleus of each cell fuses/joins together.

Fertilisation happens in the oviducts.

Fertilisation can be prevented using contraceptives such as the condom or 'the pill'. If the egg cell is fertilised, it starts to divide into a ball of cells called an embryo. The embryo implants into the lining of the uterus.

Box 8 – Gestation (Pregnancy)

Average human gestation period from fertilisation to birth is 38 weeks.

A placenta forms between the lining of the uterus and the foetus, which allows nutrients and oxygen to pass from the mother's blood to the baby's blood, and for waste products and carbon dioxide to pass back to the mother's blood.

Harmful substances such as drugs and alcohol can pass across the placenta and harm the developing baby.

The baby is surrounded by amniotic fluid which protects it from knocks and bumps. The wall of the uterus is made of muscle, which contracts to when the mother is in labour.

Key Terms	Definitions
Fertilisation	Joining of a nucleus from a male and female sex cell
Implantation	When the growing embryo becomes embedded in the thick, spongy uterus lining.
Gestation	Process where the baby develops during pregnancy. In humans it takes around 38 weeks.
Placenta	Organ that provides the foetus with oxygen and nutrients and removes waste substances.
Amniotic fluid	Liquid that surrounds and protects the foetus.
Amniotic sac	A thick membrane that encloses the amniotic fluid (and developing foetus)
Umbilical cord	Connects the foetus to the placenta.
Embryo	The developing baby from fertilisation to 12 weeks.
Foetus	The developing 'baby' from 12 weeks until it is ready to be born.

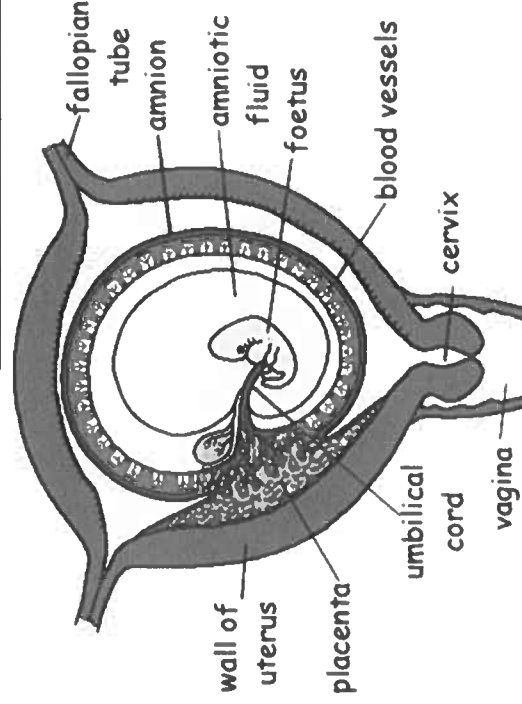

Box 9 – Birth

After about 40 weeks of pregnancy, the foetus is ready to be born.

- The muscles in the wall of the uterus contract (**contraction**)
- The cervix **dilates** (gets bigger) to **10cm**. This is big enough for the foetus's head to pass through.
- Contractions push the baby headfirst through the **cervix** and then through the **birth canal** - vagina.
- The foetus is now called a **baby**.

Year 7 Biology Knowledge Organiser - Organisation 2 - Plant Reproduction

Box 10 – Parts of a flower

Flowers contains the reproductive structures in plants. The stamen is the male part, and the carpel is the female part.

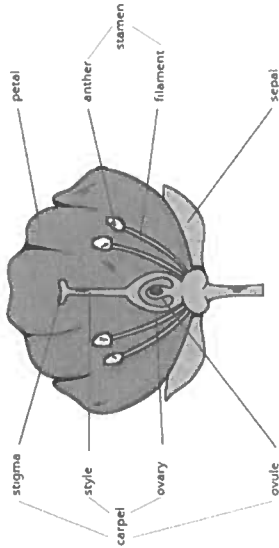

Box 11 – Functions of parts of the flower.

Part of the Flower	Function
anther	Produces male sex cells (pollen grains).
carpel	The female reproductive part of the flower, consisting of the ovary, ovule, style and stigma.
filament	A stalk-like structure that supports the anther.
ovary	Produces female sex cells (eggs).
ovule	Develops into a seed after fertilisation.
petal	May be brightly coloured to attract insects.
sepal	These protect the flower before it is opened when it is still a bud. They are often green.
stamen	The male part of a flower consisting of an anther held up on a filament
stigma	The top of the female part of the flower, which is sticky, so pollen grains stick to it.
style	The tube connecting the stigma to the ovary which pollen travels down.

Box 12 – Comparing insect and wind pollination.

Pollination is the process of pollen being transferred from the anther to the stigma. This is carried out by wind or insects, such as bees.

Insect-Pollinated Plants	Wind-Pollinated Plants
They have bright petals with a sweet smell to attract insects.	No petals or small green/brown petals, as no need to attract insects.
The stigma and anther are inside the flower.	The anther hangs loosely out of the plant to make it easier for wind to blow it from the plant.
The stigma is sticky, so that pollen carried from the insects sticks to it.	The stigma hangs outside of the plant to make it easier to catch pollen on the wind
Pollen grains are larger and can easily stick to insects. So fewer pollen grains need to be produced.	The stigma may be feathery or sticky to catch pollen blown by the wind.
The anthers are firm and rigid to allow the insects to brush against them.	They produce large amounts of pollen to increase the chances of it reaching another plant.
They often contain nectar, which is sweet and sugary to attract insects. Some bees use nectar to make honey.	Their pollen has a low mass so can be blown far on the wind.

Box 14 – Seed dispersal

Once seeds have been formed, the seeds need to be spread away from the plant that produced them. This means that the new plants aren't competing for light, space etc.

Different plants use different methods of seed dispersal. These include:

1. Wind blows them away – e.g. dandelion seeds.
2. Being eaten by animals and then spread when the animal 'poos'. E.g. cherry seeds.
3. Sticking to animals and then spread when they move around. E.g. Goose grass seeds.
4. Self-propelled – the seed bursts and propels the seed away. e.g. Himalayan balsam.

Box 13– After pollination

1. When the pollen grain lands on the stigma, it grows a tube down the style to the ovary and the ovules.
2. The nucleus of the pollen grain moves down the tube and then fertilises the ovule by fusing with the ovule.
3. The fertilised ovule then becomes a seed.

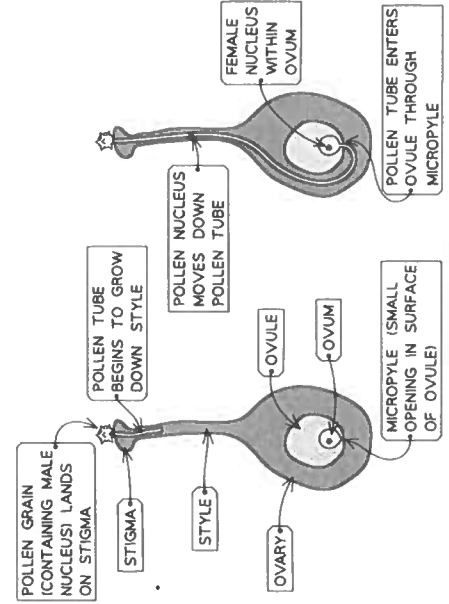

Year 7 Physics Knowledge Organiser – Electricity and Magnetism

Box 1 - Magnetic materials

Not many materials are attracted to magnets and most metals are NOT magnetic!

Iron, cobalt and nickel are magnetic metal elements. **Steel** is also magnetic as it is a mixture containing mostly iron.

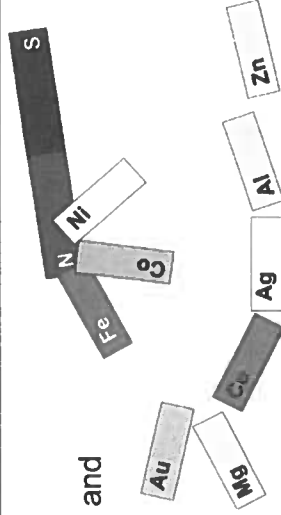

Box 2 – Rules of magnetic attraction and repulsion

Magnetic poles: All magnets have a north pole and a south pole at opposite ends of the bar magnet.

Opposite poles attract – north and south

Like (the same) poles repel – north and north

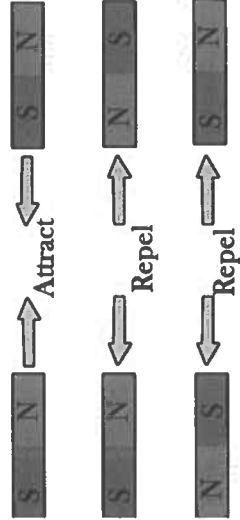

Box 4 – Compasses and Magnetism

A **compass** contains a small bar magnet (the needle) that is able to rotate freely. A nearby magnet field will cause the needle to move in line with the magnetic field.



Box 3 – Permanent and induced magnetism

Permanent magnets always have magnetic properties, eg a bar magnet.

Magnetic materials become **induced magnets** when they are in a magnetic field.

Bar magnet – permanent magnet

Magnetic materials – magnetism is temporarily induced

When the magnetic field is removed, induced magnets lose their magnetism, eg the magnetised nails will lose their magnetism when the magnet is removed.

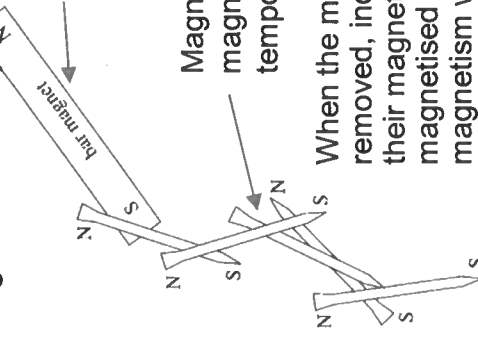

Key Terms

Key Terms	Definitions
Magnetism	A property of some materials to exert a force on other magnetic materials
Attract	Force that pulls two objects together
Repel	Force that pushes two objects apart
Magnetic poles	All magnets have a north pole and a south pole
Permanent magnet	Permanent magnets always have magnetic properties
Induced magnet	Induced magnets only act as magnets when they are in a magnetic field. When the magnetic field is removed an induced magnet quickly loses its magnetism
Magnetic field	The area around a magnet that the force acts
Magnetic compass	A magnetic compass always points along field lines in the direction of north

Box 6 – The Earth's Magnetic Field

The earth has a molten iron core which causes a magnetic field.

If there are no other magnets nearby, a compass needle points in the direction of the **Earth's magnetic field**.

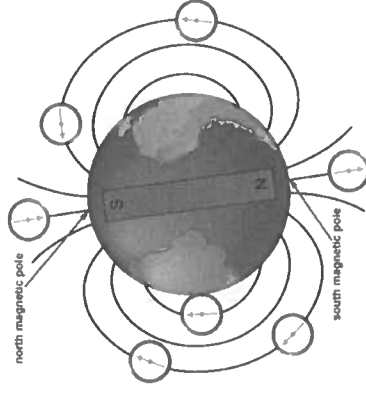

Box 5 - Magnetic fields

The area around a magnet where its force can affect other magnetic objects is called the **magnetic field**.

The magnetic field is invisible but we can use a compass or iron filings to view the shape of the field.

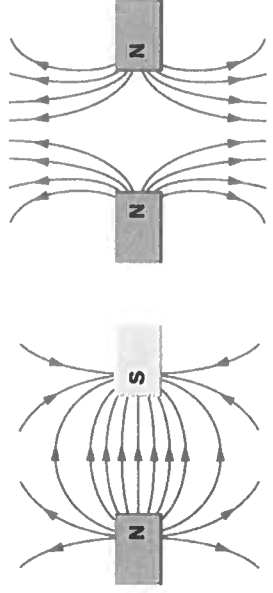

The magnet fields of attracting magnets line up, while the magnetic fields of repelling magnets do not. Field lines always point from **north to south**.

Year 7 Physics Knowledge Organiser – Electricity and Magnetism

Box 7 – Electrostatics

Some particles are charged. Charge can be positive (+), negative (-), or neutral (0).

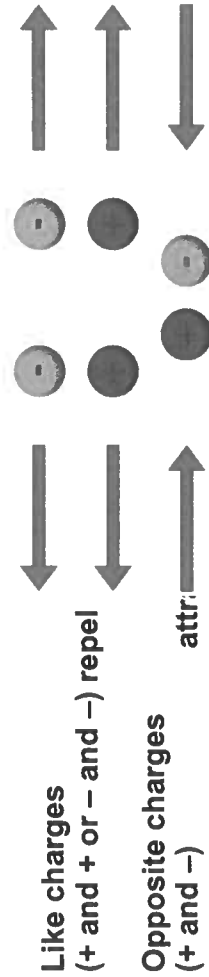

Box 8 - Charging objects with friction

Electrical insulators can become charged.

An object that is rubbed can become charged **by gaining OR losing electrons** because of the friction force.

An object that loses electrons becomes positive (+)
An object that gains electrons becomes negative (-)

(a) before rubbing
neutral amber rod neutral fur

(b) after rubbing
negatively charged amber rod positively charged fur

Box 9 – Measuring electrostatic charge

An **electroscope** can be used to detect electrical charge on objects. When no charge is present, the foil hangs freely.

A charged object will either attract or repel electrons from/to the foil leaves and onto/away from the metal pan.

The foil leaves become charged so they repel each other.
The bigger the charge, the more the foil leaves repel each other.

Key Terms	Definitions
Charge	A property of some particles, which causes them to experience a force when they are near others. Charge can be positive or negative
Proton	A subatomic particle with a positive charge
Neutron	A subatomic particle with no charge (they are neutral)
Electron	A subatomic particle with a negative charge
Electrical insulator	A material that prevents the flow of electrons
Electrical conductor	A material that allows the flow of electrons
Static electricity	This occurs when the positive and negative charges on an electrical insulator are unbalanced

Box 10 - Charged objects and forces

Objects with opposite charges are attracted to one another.

Objects with the same static charge will repel each other.

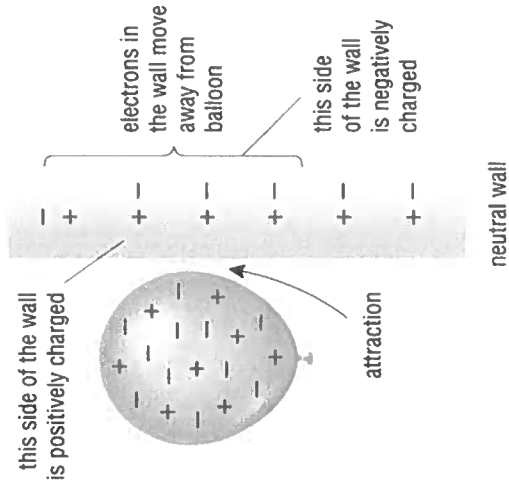
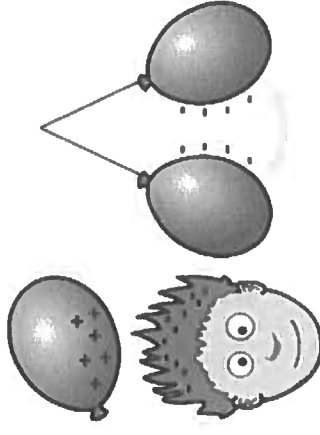

A charged object is attracted to a neutral object.

Electrons near the surface of the neutral object move when the charged object is brought near it.

This causes the surface of the neutral object to be charged so that attraction can occur.

Year 7 Physics Knowledge Organiser – Electricity and Magnetism

Box 11 – Electrical Current

Electrical current is a flow of electrical charge, usually **electrons**.

Electrical conductors allow electrons to flow through them.

A cell or battery sets up the difference in charge in the circuit, which causes electrons to flow from the negative charge towards the positive charge.

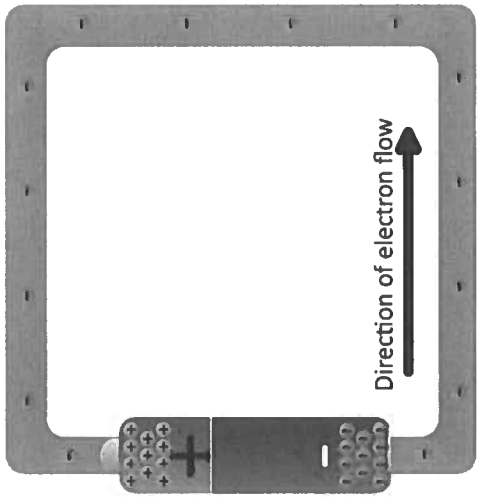

Box 12 - Drawing circuit diagrams

Symbols for components make electrical circuits easier to understand. The symbols are recognised across the world. The connecting wires are straight...

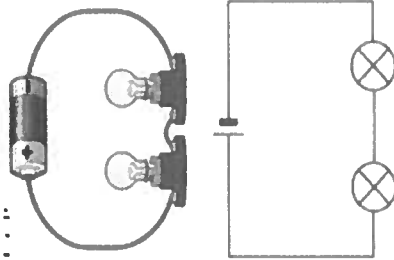

Series circuits contain only one loop or path for the current to flow along.

The more bulbs you put in the circuit, the dimmer the bulbs get.



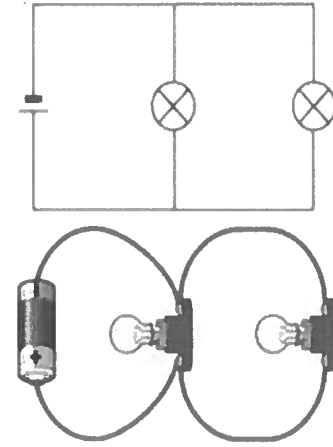



If one bulb breaks, the whole circuit stops working.



Parallel circuits contain more than one loop or path for the current to flow along.

Adding new bulbs to the circuit in their own loop (connected in parallel) does not affect the brightness of other bulbs in the circuit.

If one bulb breaks, the rest of the circuit still works!

Key Terms	Definitions
Electrical current	A flow of electrical charge.
Cell 	A chemical store of energy that can cause an electrical current to flow in a circuit.
Battery 	Two or more electrical cells working together.
Connecting lead 	A metal wire that allows current to flow through it easily.
Lamp / bulb 	A filament lamp contains a tiny wire that heats up when a current flows through it which emits light.
Open switch 	This provides a break in an electrical circuit so that current cannot flow.
Closed switch 	This connects the electrical circuit and allows current to flow.
Series circuit	An electrical circuit where all the components are connected in one loop.
Parallel circuit	An electrical circuit containing more than one loop or path for the current to flow.
Energy pathway	A way of transferring energy from one store to another, for example electrical current.

Box 13 - Electricity and energy transfer

Electrical current is an **energy transfer pathway** – it transfers energy from one store to another. We call this electrical work

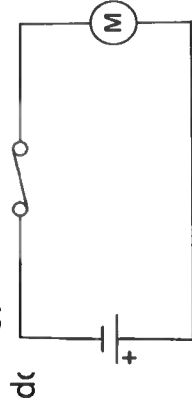

eg this circuit transfers energy from the cell (a chemical store) to the motor (a kinetic store)

Y7 History Knowledge Organiser: Historians and the Battle of Hastings

1.1 Marc Morris

In his book, The Norman Conquest, Marc Morris uses a range of sources to produce a justified narrative of events

- Historians study historical sources to find evidence about the past
- These sources are usually found in archives
- Sometimes different sources provide contradictory evidence
- All historical sources are shaped by their authorship and purpose
- Historians navigate these sources to produce interpretations
- Morris calls this producing a 'justified narrative'

VOCABULARY

Ambiguous	Unclear
Archives	Buildings where historical sources are kept
Artistic Licence	The way that artists exaggerate for dramatic effect
Authorship	Information about who wrote a source
Behead	To cut off someone's head
Chaplain	Priest
Contradictory	Saying opposite things
Disembowel	To remove someone's organs
Evidence	Material from sources that answers a question
Exaggerate	Make something seem better / worse / more dramatic
Eyewitness	Someone who saw an event first hand
Justified	A story that is supported by evidence from sources
Narrative	A historian's view of the past
Interpretation	The reason why a source was created
Purpose	Documents etc used by historians to recreate what happened in the past
Sources	

1.2 The Bayeux Tapestry

The Bayeux Tapestry is an embroidery telling the story of the Battle of Hastings

- Advantages of evidence from the Tapestry**
- ✓ Provides a visual representation of events stretching for 70 metres
 - ✓ Produced in England by English embroiderers

- Problems with evidence from the Tapestry**
- × Often ambiguous on key issues
 - × Ordered to celebrate the Norman victory by William's half-brother Bishop Odo
 - × Created 10 years after the battle

1.3 Guy of Amiens' Carmen

Guy of Amiens' poem was written soon after the battle but may exaggerate in places

- Advantages**
- ✓ Amiens was French but not Norman
 - ✓ Amiens wrote the poem less than a year after the battle
 - ✓ He talked to eyewitnesses

- Problems**
- × Written to be performed in front of William
 - × As a poet, Amiens might have used some artistic licence to exaggerate

1.4 William of Poitiers

William of Poitiers gives a detailed narrative but was writing to celebrate William's life

- Advantages of Poitiers' evidence**
- ✓ His biography of William is very detailed
 - ✓ Although he was not at the battle, Poitiers was William's chaplain and knew him well
 - ✓ Poitiers had been a soldier and understood military matters

- Problems with Poitiers' evidence**
- × He was a Norman
 - × He was writing to celebrate William's life
 - × The biography was written 10 years after the battle

1.5 The Death of Harold Godwinson

The sources contradict other on several issues, including how the English king Harold Godwinson died

The Bayeux Tapestry

- The Tapestry shows a figure with an arrow in his eye and the caption reads "King Harold was killed"
- However, it is not clear which figure is Harold

Guy of Amiens' Carmen

- The Carmen claims that William gathered his knights and deliberately set out to kill Harold - no arrow in the eye is mentioned
- Harold was killed brutally: pierced with a lance, beheaded, and disembowelled

William of Poitiers

- Poitiers doesn't discuss Harold's death, only noting that his body could not be recognised by his face
- Poitiers had read the Carmen and perhaps found William's actions shameful

Y7 History Knowledge Organiser: Medieval Monarchs

Timeline	
1066	William I becomes king
1120	White Ship Disaster
1153	Treaty of Winchester
1183	Murder of Thomas Becket
1202	French invasion of Normandy
1215	King John signs Magna Carta
1348	The Black Death
1381	The Peasants Revolt

KPI 2 Royal Touch

Appointed by God

Medieval monarchs believed that they had been appointed by God.

The Royal Touch was the idea that the monarch's touch could cure a common skin disease called **scrofula**. People believed that monarch's could signal to God to cure the sufferer.

Touch pieces were later used so that the monarch could cure more people.

The Royal Touch

This relationship between God and the monarch was clear in the Royal Touch.

The Royal Touch was the idea that the monarch's touch could cure a common skin disease called **scrofula**. People believed that monarch's could signal to God to cure the sufferer.

Touch pieces were later used so that the monarch could cure more people.

KPI 1 Medieval Kings

- Edward the Confessor, 1042 to 1066
- King Harold II, 1066
- King William I, 1066 to 1087
- King William II, Rufus, 1087 to 1100
- King Henry I, 1100 to 1135
- King Stephen, 1135 to 1141
- Empress Matilda, 1141 to 1142
- King Stephen, 1142 to 1154
- King Henry II, 1154 to 1189
- King Richard I, 1189 to 1199
- King John, 1199 to 1216
- King Henry III, 1216 to 1272
- Edward I, 1272 to 1307
- Edward II, 1307 to 1327
- Edward III, 1327 to 1377
- Richard II, 1377 to 1399
- Henry VI, 1399 to 1413

KPI 3 The Anarchy

The White Ship Disaster

In 1120, Henry I's only legitimate son - William - died when his ship sunk in the White Ship disaster.

Henry had no other legitimate male heirs so he named his daughter - Matilda - as his heir.

However, when Henry died, his nephew - Stephen - seized the throne. This began the Anarchy - a period of chaos in which Matilda and Stephen competed for the throne.

1135 Stephen seized the throne

- 1139 Matilda invaded England
- 1141 Stephen defeated at the Battle of Lincoln
- Matilda rejected by the people of London
- 1148 Matilda returned to Normandy
- 1153 Treaty of Winchester: Stephen named Henry, Matilda's son, as his heir
- 1154 Stephen died. Henry II king

The Anarchy revealed that the power of medieval monarchs was based on a wide variety of factors:

- Monarchs gained **legitimacy** because they inherited their power from a previous monarch
- Female monarchs were seen as weak because they could not lead an army into battle
- Monarchs could gain power and **legitimacy** by showing their military strength by winning battles
- Monarchs needed the support of powerful people, such as the **barons** or the **Pope**
- Monarchs needed to be popular. Unpopular monarchs could be rejected or face **rebellion**

KPI 4 The Church

Heaven and Hell

People in the Middle Ages believed that heaven and hell were real places.

After death, they believed, angels would decide if you would spend eternity in heaven or hell.

Getting into Heaven

There were several ways to increase your chances of going to heaven and avoiding hell:

- Becoming a nun or a monk and spending life in a nunnery or monastery.
- Nuns and monks dedicated their lives to God, praying eight times a day and serving their community.
- The rich often gave money to support monasteries.
- Earning an indulgence.
- These were certificates that forgave sins. They could be bought or earned by charity work.
- Going on crusade.
- Christians and Muslims fought over the holy city of Jerusalem. The Pope promised to forgive the sins of crusaders.

Heaven was the kingdom of Jesus. It was reserved for those who had lived a good life.

Hell was the kingdom of the Devil. Sinners were sent here. Living in hell meant an eternity of pain and suffering.

Church Hierarchy

- The Pope**
God's representative on earth. Lived in Rome. Could excommunicate kings.
- Archbishop of Canterbury**
The Pope's representative in England and the most powerful member the Church.
- Bishop**
The leader of the church in a local area. There were 17 bishops in the Medieval Church, each based at a cathedral.
- Priest**
Each town and villages had a priest to run church services.

KPI 5 The Murder of Thomas Becket

In the Middle Ages, it was unclear whether the King had more power than the Church. This was demonstrated in the story of Thomas Becket:

In 1162, Henry II named his friend Thomas Becket as **Archbishop of Canterbury**.

Henry wanted Becket to force priests to use the **King's Courts**, instead of getting away with light punishments in the **church courts**. He also wanted Becket to help him control the bishops.

When Becket refused to do this, the two men fell out. In a rage, Henry shouted "Will no one rid me of this troublesome priest?". A group of knights overheard him and murdered Becket.

Henry was horrified when he heard of Becket's death and ordered monks to whip him to show he was sorry.

Y7 History Knowledge Organiser: Medieval Monarchs

KPI 6 King John

Why was John unpopular?

John was forced to introduce a new land tax to repay money that his brother, Richard I, had borrowed to pay for the Crusades.

The French invaded English territory in Normandy. John tried to win it back but lost the Battle of Bouvines in 1214. He was nicknamed 'Softsword'.

John tried to force the Church to accept his choice for Archbishop. In response, the Pope excommunicated John and stopped church services in England.

Baron's Revolt 1215

In May 1215, 40 English barons rebelled against King John.

With support from the French and Scottish, they formed an army and captured London.

John met the rebels at Runnymede, near London and agreed to Magna Carta.

Magna Carta

Magna Carta - or 'Great Charter' - was a document signed by King John limiting the power of kings. It was the first time that a set of rules had been written for the king.

The most important parts:

- Gave all free men the right to trial by jury
- Limited the amount of tax the barons had to pay
- Limited the power of the King over the Church

KPI 7 Peasants Revolt

Why did the peasants revolt in 1381?

Most people in England were peasants. They grew all the food but owned no wealth and lived in poverty. They were led by John Ball, a priest who questioned this inequality.

In 1348, the Black Death killed 50% of the population. The few peasants who survived could demand higher wages and this led to increasing tension between rich and poor.

In 1381, the government introduced a new tax - the poll tax. Everyone paid the same. The peasants thought it was unfair that a rich man should pay the same as them.

What happened in the peasants revolt?

50,000 rebel peasants marched to London and camped on Blackheath, south of the River Thames

The 14 year old king, Richard II, took his barge down the Thames to meet the rebels but turned back when he saw the size of their force

In response to this rejection, the rebels attacked the city. They broke in to the Tower of London and executed Sir Robert Hales, the king's unpopular advisor, and the Archbishop of Canterbury.

Richard finally met Wat Tyler, the leader of the rebels, at Smithfield. The king agreed to Tyler's demand for a Magna Carta for all people - making all men equal under the king.

When Tyler was stabbed and the violence seemed ready to start again, Richard calmed the situation by saying "You shall have no other captain but me." The rebels went back home.

Richard went back on his word. He did not make everyone equal under the king. The leaders of the rebellion were executed

VOCABULARY

Archbishop	Leader of the Church in England
Barons	Powerful landowners
Black Death	A deadly disease killing 50% in 1348
Bishop	Leader of the Church in a local area
Cathedral	A large church
Charter	A contract
Church courts	Places where church men were punished
Crusade	Christian war against Islamic forces
Eternity	Forever
Equal	The same
Excommunicate	Expel from the Church
Executed	Killed
Heir	Someone to become king next
Indulgence	A certificate forgiving sin
Inequality	The gap between rich and poor
Inherited	Passed down from a family member
King's Courts	Places where everyone was punished
Legitimate	Proper and right, accepted by everyone
Legitimacy	Being legitimate
Monarch	A king or queen
Monk	A man who gives up his life to God
Nun	A woman who gives up her life to God
Peasants	Landless poor farmers
Poll Tax	Money that everyone had to pay
Pope	The leader of the Church (lives in Rome)
Rebellion	When ordinary people rise up against govt
Rebels	People who are rebelling
Tax	Money paid to the government
Territory	Land
Trial by jury	When ordinary people decide what happens
Scrofula	A skin disease
Seized	Taken control of
The Anarchy	Period of chaos
Touch Pieces	Coins that had been touched by the King
Treaty	An agreement to stop fighting

1.1 The Islamic World

Islam was founded by the prophet Muhammad in 610 in the Arabian cities of Mecca and Medina. Within 100 years Arab armies had spread Islam eastwards into Asia and westwards into North Africa. At it's height the Islamic world stretched from Spain to India.

A Golden Age - A golden age of science was born in the Islamic World during the Middle Ages. Major advances were made in maths, astronomy, and medicine.

Contrast with Western Europe - Learning was not valued highly in western Europe. Only 5% of western Europeans could read and write. Charlemagne, the most powerful king in Europe, couldn't write his name.

1.2 Islam and Science

Ibn al-Haytham - Al-Haytham was a pioneer of the science of optics. His camera obscura experiment proved that light travels in a straight line. Al-Haytham believed that studying the natural world would bring him closer to God. He said "For gaining closeness to God, there is no better way than that of searching for truth and knowledge."

Islamic belief stimulated scientific discovery

Prayer - Muslims pray towards Mecca 5 times a day, at dawn, midday, afternoon, sunset, and night. Muslims needed to know the time of day and the location of Mecca. This led to the development of the astrolabe and astrology.

Hadith - The Hadith are a the teachings of Muhammad, the most important prophet of Islam. The Hadiths encouraged Muslims to learn. For example, "Seek knowledge from the cradle to the grave"

Eid - Eid is an important religious holiday. The date of Eid is determined by the moon. Muslims needed to understand the cycle of the moon. This led to the development of lunar calendars.

1.3 The Astrolabe

The astrolabe was a handheld device developed in the Islamic World during the Middle Ages. The astrolabe works by stereographic projection – this means the stars are projected onto the brass plate. During the day time, the astrolabe can be lined up with the sun in order to measure the exact time. During the night, the astrolabe can be lined up with the stars for navigation.

The astrolabe was essential for practicing Islam. At any time of day or night, Muslims could work out: When to pray & The direction of Mecca. The astrolabe could also be used to work out the timing of religious festivals such as Eid. The astrolabe could be used for navigation by the stars. Navigation was difficult in a featureless desert or at sea and it was too hot to travel during the day. Astrolabes could used to measure the height buildings which was crucial in surveying.

The **astrolabe** had a significant impact: it allowed a sophisticated understanding of **astrology**. Stars, such as **Altair** and **Aldebaran** still bear **Arabic** names & European and **Arabic** explorers used the **astrolabe** to **navigate** at sea, allowing them to explore new territories.

Al-Khujandhi used astrolabes to measure the height of the sun above the horizon. This allowed him to work out that the world was tilted by 23 degrees. Calculating the axial tilt was important because it helped understand the seasons. Mariam al-Astrulabi made highly accurate and intricate astrolabes. Al-Astrulabi was employed by Sayf al Dawla, the ruler of a powerful empire in Syria.

1.4 Al-Khwarizmi and Mathematics

Al-Khwarizmi was a mathematician who was the director of the House of Wisdom during the 9th Century. The House of Wisdom was a library and a centre for scholars working on science, maths, and philosophy. It was based in Baghdad, in modern day Iraq.

Advances in Mathematics

Numbers - Al-Khwarizmi studied Indian mathematics, which used a different number system to the Roman numeral system used in Europe. Al-Khwarizmi introduced a new Arabic numbering system – which we use today – as well as the decimal point.

Algebra - In his book, Al-Jabr, published in 820, Al-Khwarizmi introduced the concept of algebra: simplifying mathematical problems by using symbols and rules.

Algorithm - Al-Khwarizmi gave his name to the mathematical process of algorithms: breaking down complicated processes into simple steps.

Reasons for success

Scholars at the House of Wisdom translated texts from around the world into **Arabic**. Al-Khwarizmi could therefore learn from **Indian** and **Greek** mathematicians and bring their ideas together. Al-Khwarizmi was supported by the Abbasid caliph Al-Mamun, which meant he had time to research, a large salary, and support from the caliph.

Impact

Khwarizmi's work on algorithms is the basis for modern computing. An iPhone, for example, is programmed with thousands of different algorithms. Algorithms are also used in search engines. During World War II, the British scientist Alan Turing used algorithms to crack the German secret code.

1.4 Caliph Al Mamun

The Abbasid Caliphate dominated the Middle East and North Africa from the 8th to the 13th Century. The Abbasid Caliphate was ruled by powerful caliphs. Al-Mamun (caliph from 813 to 833) was a great patron of science. He supported scientific research because...

...he wanted a healthy population to fight in wars. There were 800 doctors in Baghdad in the 9th century. Later caliphs encouraged the work of doctors such as Ibn Sina, who wrote a medical encyclopaedia.

...he wanted to produce enough food to feed his people. The caliphs encouraged engineers such as Ismail Al-Jazari, who invented a water raising machine for irrigating crops. Scientists researched new crops from the empire, including rice from India.

...he wanted to have an accurate map of his empire. Al-Mamun ordered a new map of the world to be produced with important Islamic cities on it. Astrolabe makers such as Mariam Al-Astrolabi were employed to help with working out distances.

Vocabulary

Astrology	The study of the stars and their influence on the earth
Arabic	The language of Islam
Axial tilt	How far the earth is tilted off straight
Baghdad	The capital of the Abbasid Caliphate
Caliphate	An Islamic Empire
Caliph	The ruler of an Islamic Empire
Cradle to the grave	For your whole life
Eid	Important Islamic festival
Hadith	The sayings of the prophet Muhammad
Intricate	Small and complicated
Irrigating	Watering plants
Lunar calendar	A calendar based on the movement of the moon
Mecca	The holiest city in Islam
Motivation	The reasons why you want to do something
Muhammad	The most important prophet in Islam
Navigation	Finding your way somewhere
Optics	The study of light
Patron	Someone who provides money and support for an artist or scientist
Pioneer	Someone who is the first to do something
Prophet	An important religious figure who shares the word of God
Qu'ran	The holy book in Islam
Roman numerals	I, II, III, IV, V, VI, VII, VIII, IX, X, etc
Scholars	People who study and research for a living
Scientific method	Basing ideas on proof from experiments
Surveying	Measuring accurately the dimensions of a building or piece of land

Geography Topic 3 - Is Africa a Misrepresented Continent?

Key words.

- **Abolishing:** Ending
- **Abundant:** A lot of something
- **Biomes:** a large area that has similar climate conditions, plants and animal life.
- **Cash Crops:** Crops that make a lot of money
- **Colonialism:** The practice of acquiring control over another country, occupying it with settlers, and exploiting it economically
- **Development:** The progress of a country in terms of economic growth, the use of technology and human welfare.
- **Development Indicators:** a method used to measure how developed a country or region is.
- **Donors:** People who give money or aid
- **Economic Exploitation:** The act of selfishly taking advantage of someone/resources to get more money
- **GNI:** A measurement of economic activity.
- **Historical:** In the past
- **Imperialism:** importing influence/power through military force, wealth or diplomacy
- **Independence:** Being able to do things for yourself and make your own decisions
- **Investment:** The action of investing money for profit
- **Labour:** The workforce
- **Landlocked:** A country which has no access to the ocean
- **Manufacture:** Making products
- **Misconceptions:** Preconceived ideas about something with little evidence to support it
- **Modernise:** To make modern
- **Physical:** The shape of the land, natural features
- **Superiority:** The state of being better than
- **The Development Gap:** The difference in wealth between richer and poorer countries

KPI 1 What is development?

In the 1980s the Geographers tended to use the Brandt line to split the world into the 'rich north' and 'poor south' but this was too simplistic. We now categorise (group) countries into the following categories:

- **HIC:** High Income Country- the wealthiest countries in the world with a high quality of life e.g. UK, USA, France Germany
- **NEE:** Newly Emerging Economy - Rapidly getting richer and the quality of life for its citizens (the people who live there) is improving e.g. India, China, Brazil and Russia
- **LIC:** Low Income Country - The poorest countries in the world with a low quality of life e.g. Afghanistan, Somalia, USA

What are the causes of uneven development?

- **Physical Causes:** Natural factors such as climate (average weather) and natural disasters e.g. an earthquake could destroy schools in an area and as a result there will be lower literacy rates
- **Economic Causes:** Factors relating to money, wealth and/or the economy e.g. a corrupt leader may take a bribe to sell goods to a HIC for a much lower price
- **Historical Causes:** Factors relating to a country's past that still impact them today e.g. when a country gains independence (make their own decisions) they may not have qualified people to lead causing a power struggle

KPI 2 How to measure development?

To understand the differences in quality of life it is necessary (needing to do something) look at different **development indicators**

Social (people) Measures of Development:

- **Birth Rate:** The number of babies born per 1000 people per year
 - **Death Rate:** The number of deaths per 1000 of the population per year
 - **Infant Mortality Rate:** The total number of babies that die before reaching the age of one per 1000 live births
 - **Patients per Doctor:** The average number of people for each doctor
 - **Literacy Rate:** The percentage of adults who can read and write
 - **Life Expectancy:** The average number of years a person lives
- Economic (money) Measures of Development:*
- **Gross Domestic Product:** The total value of goods produced by a country
 - **Gross National Income:** Measures the income generated by the residents (people living in a country) of a country

The most reliable measure of development is the **Human Development Index** as it is a social and an economic measure. a statistic used to measure the human development of a country, combining several indicators of health, education, and wealth.

KPI3 – What is the physical geography of Africa?

Major Physical Features include:

1. **Sahara Desert:** The world's largest hot desert, covering much of North Africa.
2. **Nile River:** The longest river in the world, flowing northward through northeastern Africa to the Mediterranean Sea.
3. **Great Rift Valley:** A major geological and geographical feature running from the Red Sea down through East Africa.
4. **Atlas Mountains:** Stretching across Morocco, Algeria, and Tunisia in the northwest.
5. **Ethiopian Highlands:** A rugged mountainous region in Ethiopia, known as the "Roof of Africa."
6. **Kalahari Desert:** A large semi-arid sandy savanna in Southern Africa.
7. **Congo Basin:** Home to the second-largest rainforest in the world, centered around the Congo River.
8. **Namib Desert:** A coastal desert in Namibia known for its high sand dunes.
9. **Mount Kilimanjaro:** Africa's highest peak, located in Tanzania.

Biomes include:

1. **Deserts:** The Sahara, Namib, and Kalahari are the primary deserts, characterized by arid conditions and sparse vegetation.
2. **Savannas:** Grasslands with scattered trees, prevalent in regions like the Serengeti, supporting large populations of herbivores and predators.
3. **Rainforests:** Dense tropical rainforests are primarily located in Central Africa, notably in the Congo Basin.
4. **Mediterranean:** Found along the northern coast and parts of South Africa, characterized by dry summers and wet winters.

Climate includes:

Climate:

1. **Equatorial:** Hot and humid year-round, with significant rainfall, primarily in Central Africa.
2. **Tropical Wet and Dry:** Characterized by distinct wet and dry seasons, prevalent in the savannas.
3. **Arid:** Dominates the Sahara and parts of the Horn of Africa, with minimal rainfall and extreme temperatures.
4. **Semi-arid:** Found in the Sahel, the transition zone between the Sahara and the savannas.
5. **Mediterranean:** Northern and southern coasts, with mild, wet winters and hot, dry summers.

KPI4 - How has Africa's past shaped its present?

- **Before 1800:** Africa was divided into thousands of small areas and kingdoms
- **Between 1600s and 1800s:** 12-15 million Africans were sold into slavery in the slave trade. Europeans bought people in West Africa in exchange for goods
- **1833-1960s:** The Scramble for Africa and Colonialism: European nations were keen to exploit the abundant (available in large quantities) natural resources and cheap labour of Africa that had been discovered by explorers. To prevent conflict over resources during the period known as the 'Scramble for Africa' 14 European countries met and divided the continent amongst themselves. This led to communities being separated and even straight-line borders being introduced between countries dividing populations

Why did some African countries struggle after independence?

- **Not Enough Infrastructure:** When Europeans left, there weren't enough roads, schools, or hospitals. This made it hard for countries to grow and have good lives for their people.
- **Energy Dependence:** African countries needed energy from Western countries. They didn't have the equipment to make their own, like oil refineries. Trying to build these, like the dam in Ghana, put them in debt.
- **Inexperienced Leaders:** The leaders in Africa didn't have much experience because the Europeans hadn't let them have important jobs. This led to bad decisions and corruption.
- **No National Unity:** The borders of African countries were drawn by Europeans without considering the different groups living there. This caused fights between different groups, like in Rwanda.
- **Cold War Problems:** During the Cold War, the USA and USSR gave money and weapons to different groups in Africa, causing wars, like in Angola.
- **Debt:** In the 1970s, African countries borrowed a lot of money for projects that often failed. By the 1980s, they could only pay the interest on their loans, keeping them poor. Some debt was forgiven in the 2000s, but the damage was already done.

Geography Topic 3 - Is Africa a Misrepresented Continent?

KPI 5 Does China want to help African countries to develop?

Case Study: Ethiopia

Location: Ethiopia is located in East Africa just north of the Equator. It is surrounded by Kenya to the south and Somalia to the east.

- Ethiopia has the second largest population in Africa with over 100 million people
- While 80% of the population is still rural (countryside), cities are growing quickly

What are the problems in Ethiopia?

- Migration into cities have led to a growth in slums. Slums are areas. A slum is a residential area with substandard housing that is poorly serviced and/or overcrowded, and therefore unhealthy, unsafe.
- In 2000, Ethiopia was one of the poorest countries in the world

How has China helped develop the economy?

- Financial (*money*) support from China has allowed the building of the Addis Ababa to Djibouti railway. This is one of a series of projects that China has funded in Africa

Positives of Chinese intervention in Ethiopia

- More **infrastructure** (*roads, railways, sewage etc*) is built that supports the Ethiopian economy
- Chinese companies invest in Ethiopia and can provide a greater number of jobs

Negatives of Chinese intervention in Ethiopia

- Many projects in Africa involve using Chinese labour (*workers*) so they do not create jobs for Africans
- Africa is opening itself up to a 'new form of **imperialism**' in which China takes African natural resources and sells its **manufactured** ones, without transferring skills
- China still extracts a large number of resources to send to China, potentially leaving Ethiopia without as many resources

KPI6 – What is the physical geography of the Horn of Africa?

Region: A *region* is a large area where the places have something in common

The Horn of Africa is made up of four countries:

- Ethiopia
- Somalia
- Djibouti
- Eritrea
- They have a shared history. There were several ancient civilizations in this region that crossed today's country borders
- Ethnic groups are spread across the region. The Somali people live in Somalia, Ethiopia, Eritrea and Djibouti. The Afar live in Ethiopia
- The region is in the tropics. But much of it is semi-desert. Only the Ethiopian Highlands get a lot of rain
- The region is poor but is now developing quite fast

Physical Geography

Climate:

1. **Arid and Semi-Arid:** Much of the Horn of Africa experiences hot, dry conditions with low rainfall, especially in desert areas.
2. **Coastal Climate:** Coastal areas, particularly along the Red Sea and the Indian Ocean, have hot and humid conditions with occasional monsoonal rains.

Landforms:

Major Landforms:

1. **Ethiopian Highlands:** This mountainous region, often called the "Roof of Africa," features elevations (heights) exceeding 3,000 meters.
2. **Great Rift Valley:** Running through Ethiopia, this significant feature is marked by deep valleys and volcanic activity.
3. **Deserts:** The Danakil Desert in northeastern Ethiopia and Eritrea is one of the hottest places on Earth, while the Somali Desert extends into Somalia, characterized by arid (dry) conditions.
4. **Coastal Areas:** The region has a lengthy coastline along the Red Sea and the Indian Ocean.

KPI7 – What factors have affected development in the Horn of Africa?

Climate: Ethiopia often suffers from drought which causes problems for its' farming sector. Frequent crop shortages leads to food shortages, affecting the quality of life for its citizens. It also has water shortages due to the high temperatures and lack of rainfall.

Conflicts: In Somalia continuous (non-stop) fighting has disrupted services, slowed education, and forced people to move, resulting in lack of people working, lack of income, and lack of development. Conflict (fighting) has meant big companies don't want to invest there. In Mogadishu, the capital of Somalia - the civil war has destroyed the city's infrastructure and stopped economic progress.

Colonialism: Until 1977, Djibouti was ruled by France. Like many countries under colonial rule, the country in control benefitted far more, and the country being controlled essentially 'worked' for the country that ruled. The French established Djibouti as a key port for trade and military purposes. However, the economic benefits and profits largely went to France, leaving, Djibouti with low income, slow development and infrastructure they couldn't use to their advantage.

KPI9 – How can employment close the development gap in the Horn of Africa?

Fair trade: A movement that aims to support farmers and ensure they receive a fair price for their work.

Without fair trade then:

- **Unfair Prices:** Farmers in developing countries might receive very low prices for their products, making it hard for them to make a living and support their families.
- **Limited Opportunities:** Communities may struggle to invest in education and healthcare, limiting opportunities for growth and development.
- **Environmental Damage:** There might be less focus on environmentally friendly farming practices, contributing to deforestation, pollution, and other harmful impacts on the planet.
- **Exploitation:** Workers could face poor working conditions, long hours, and low wages, leading to exploitation and a cycle of poverty in many communities.

In Kenya due to fair trade, farmers are paid a fair price (\$1.80 per pound of beans), which means they can invest in better equipment.

Tourism: An industry that supports people travelling for pleasure.

Tourism brings in a lot of income in Djibouti.

1. There are lots of jobs in hotels in Djibouti.
2. Over 4000 people work in tourism, so have a reliable and stable income.
3. The tax which is paid can then be reinvested back into the economy.

KPI8 – What employment is found around the world?

There are 4 employment sectors primary, secondary, tertiary and quaternary. The secondary sector involves manufacturing and was traditionally located in the inner city.

Key definitions:

- **Primary:** involves the production or extraction of raw materials and includes forestry, farming, fishing and mining.
 - **Secondary:** is the manufacturing of goods.
 - **Tertiary:** involves providing services to people, for example a cleaner or a doctor.
 - **Quaternary:** the newest sector and focuses on knowledge-based industries or high-tech industries such as ICT (information and communication technologies) and research and development.
- If a country moves from the primary to the quaternary sector, the economy often develops due to the multiplier effect.

Multiplier effect: Snowballing of economic activity

1. People in the quaternary sector are paid a higher wage as their skills are in high demand.
 2. With higher paid jobs, the government gets more money via taxes paid.
 3. With extra money from taxes the government spends money on infrastructure.
- 2.5. A higher income, means more disposable income, local people spend money in other businesses.
- 3.5 More businesses are set up as people are spending more money in the local area.

Year 7 Topic 4 What processes have shaped the UK?

Key words

- **Ice Sheet:** A mass of glacial ice more than 50,000 square kilometres (19,000 square miles).
- **Ice Age:** a long interval of time (millions to tens of millions of years) when global temperatures are relatively cold and large areas of the Earth are covered by continental ice sheets and alpine glaciers.
- **Tundra:** is an area of the world where the temperatures are so cold that there is a layer of permanently frozen ground below the surface.
- **Erosion:** materials are worn away
- **Glacier:** a sheet of ice that moves slowly down a river valley
- **Glaciologists:** Earth scientists who investigate glaciers around the world.
- **Glaciated Valley:** a river valley widened and deepened by the action of glaciers
- **Ice Age:** a period of colder climate when ice sheets form on the land, causing a lowering of sea level
- **Ice Sheet:** huge mass of ice covering the landscape that moves very slowly.
- **Moraines:** frost-shattered rock debris and material eroded from the valley floor and sides, transported and deposited by glaciers.
- **Plucking** - where rocks are pulled from the ground when water freezes onto them
- **Freeze-thaw weathering** is a process of erosion that happens in cold areas where ice forms. A crack in a rock can fill with water which then freezes as the temperature drops. As the ice expands, it pushes the crack apart, making it larger.
- **Abrasion** - loose rocks carried in the glacier scrape along the ground like sandpaper
- **Deposition** - when a glacier retreats it drops the material it is carrying.
- **Transportation** - when a glacier moves material across large distances. It happens at the base, inside and on top of a glacier
- **Snout:** the end of the glacier where melting occurs.
- **Glacial Till:** the sediment deposited by a glacier

KPI 1 What was the British Isles like 20,000 years ago?

The last **ice age** began 110,000 years ago and ended 10,000 years ago. The British Isles was covered by an **ice sheet and tundra**. Today there are two ice sheets which cover most of Greenland and Antarctica. During the last ice age, ice sheets also covered much of North America and Scandinavia.

Animals, plants and people could not live on ice sheets but can live in tundra. For example the woolly mammoth. They had adaptations (changes in the body to suit a location) that meant they could survive in the extreme cold. Adaptations included having smaller ears to conserve heat, being covered in fur to keep them warm.

KPI 2 Where is all the ice?

A glacier is a slowly moving mass of ice. They cover about 10% of the Earth's surface in cold regions such as Antarctica and the Arctic as well as in high mountain ranges such as The Alps and Himalayas.

They form in locations where average annual (yearly) temperatures are near freezing point. Large amounts of snow will fall during winter months. Temperatures throughout the year are not high enough to melt the previous winter's build-up of snow. Each year, new layers of snow bury and compress the previous layers turning them into ice.

Glaciers are found in upland and mountainous areas because the temperatures are low enough for glacial ice to form

Altitude – height above sea level – it is often measured in meters

As altitude increases temperature decreases

Glaciers are also found in higher latitudes – these are places far from the Equator

Latitude – distance from the Equator measured in degrees
It is colder at higher latitudes because the Sun's heat is spread out over a larger area meaning glacial ice can form

KPI3 How do glaciers work?

Glaciers erode landscapes in two ways:

1. **Plucking** takes places where loosened blocks of bedrock become frozen to the base of the glacial ice. As the ice moves forward, the rock frozen to the ice moves with it and is plucked from the bedrock.
2. As the ice moves forward, these rocks scrape against the bedrock, wearing it away. This is called **abrasion**. It leaves behind smooth, polished rock surfaces which have scratches on them called striations.

As glaciers transport material it carries large amounts of rock, this debris is called **moraine**. As the ice melts, the material it was transporting is called **deposition**.

KPI 4 How do corries form?

An armchair shaped hollow found on the side of a mountain where a glacier can form

Corrie Formation:

1. Snow collects in the sheltered hollow on the side of a mountain.
2. More snow is added which compacts down to form ice.
3. The back of the corrie gets steeper due to freeze-thaw and plucking
4. The base becomes deeper due to abrasion
5. As the glacier gets heavier it moves down hill through rotational slip
6. There is less erosion at the front of the corrie forming a lip
7. After the glacier melts a lake forms in the hollow called a corrie lake or tarn

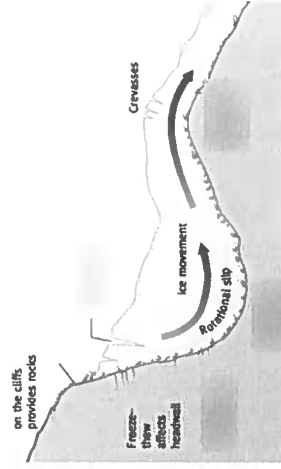

Year 7 Topic 4 What processes have shaped the UK?

KPI5 – How do pyramidal peaks and aretes form?

When two corries develop side by side, the glaciers erode the rock between them leaving a knife-like edge called an Arete. When three or four corries develop around a mountain top, a steep pointed peak is formed – this is called a pyramidal peak.



KPI 6 How do hanging valleys form?

U-shaped valleys: Glaciers change V-shaped valleys into U-shaped valleys. The ice has great erosive power and removes any obstacles.

Hanging valleys: Once the ice melts and the river flows once more, the streams and their small valleys are left 'hanging' above the new U-shaped valley floor. This can create waterfalls.

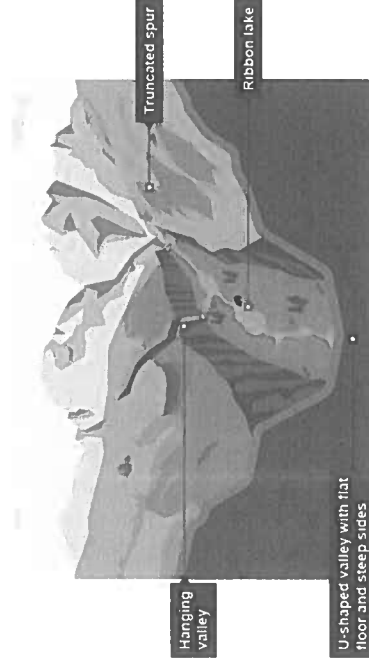

KPI 7 How do glaciers transport and deposit material?

At the **snout** of the glacier, the ice melts, so this material can no longer be carried by the ice. It is therefore dumped or deposited. This rock debris is called **glacial till**. It is a random mixture of boulders, rocks, sand and clay.

What are the different types of moraine?

- **Terminal moraines** are found at the terminus or the further (end) point reached by a glacier.
- **Lateral Moraines** are found along the sides of the glacier.
- **Medial moraine** are found at the junction between two glaciers
- **Ground moraines** are disorganized piles of rocks of various shapes, sizes and of differing rock types

KPI 8 What landforms are formed by glacial deposition?

Features of **glacial deposition**

- **Erratic's:** Very large boulders that have been carried a long way by the glacier. When the ice melts, the boulders drop. They are formed from a very different rock from the bedrock they are deposited on.
- **Drumlin:** Smooth, egg-shaped hills that are 100-800m long, and 25m-100m high. They are usually found in groups. They are formed from glacial till, deposited by the glacier while the ice is still moving. The end facing the glacier often has a steeper slope than the other end.
- **Moraine:** Debris (*anything broken down*) that has been carried by the glacier, forming long ridges, made up of till. The moraine is given different names depending on where on the glacier it is deposited.
- **Glacial Till:** The debris that has been transported by the glacier is deposited where it melts. It is made up of a mixture of rocks and clay.
- **Outwash plains:** As the glacier melts, streams flow away from the glacier. These powerful streams are swollen by meltwater. They transport large amounts of debris from the glacier snout. The largest and heaviest debris is difficult to move so it is left as a moraine. The lightest clay-sized particles are carried furthest away from the snout, eventually deposited as outwash plains.

Year 7 French - Module 2 – My town + TV & Film

1	I live in a town which is located in the north of France	J'habite dans une ville qui se trouve dans le nord de la France
2	I live in a small house which is located in the west of the United Kingdom	J'habite dans une petite maison qui se trouve dans l'ouest du Royaume-Uni
3	Now my region is modern	Maintenant ma région est moderne
4	Before my area was clean	Avant ma zone était propre
5	On my road there is a cinema	Dans ma rue il y a un cinéma
6	But unfortunately there is no swimming pool	mais malheureusement il n'y a pas de piscine
7	From time to time in my village I travel by car to go to school	De temps en temps dans mon village je voyage en voiture pour aller à l'école
8	Everyday in my town I go by train to visit my friends	Tous les jours dans ma ville je vais en train pour visiter mes copains
9	If I had the opportunity I would go by plane to travel the world	Si j'avais l'occasion j'irais en avion pour voyager autour du monde
10	If I could I would travel by boat to go on holiday	Si je pouvais je voyagerais en bateau pour aller en vacances

Year 7 French - Module 2 – My town + TV & Film

11	I would say that I love the news because I find them interesting	Je dirais que j'adore les informations parce que je les trouve intéressantes
12	I don't like music programmes because they are boring	Je n'aime pas les émissions de musique car je les trouve ennuyeuses
13	However, my friend likes sports programmes, he thinks that they are exciting	Cependant mon copain aime les émissions de sport il les trouve passionnantes
14	But my mother prefers reality TV programmes, she thinks they are funny	Mais ma mère préfère les émissions de télé-réalité, elle les trouve amusantes
15	Sometimes I watch action films on TV	Quelquefois je regarde des films d'action à la télé
16	Usually we watch science fiction films at my friends house	D'habitude nous regardons des films de science fiction chez mon copain
17	Twice a week I like to watch comedies after school	Deux fois par semaine j'aime regarder des comédies après le collège
18	However, I never watch crime/ police films in the evening	Cependant je ne regarde jamais de films policiers le soir
19	But I do not watch anymore horror films in the cinema	Mais je ne regarde plus de films d'horreur au cinéma

Year 7 French - Module 2 - My town + TV & Film

20

But I don't watch tragedies before school

Mais je ne regarde pas de tragédies avant le collège

MFL key classroom language:

Key Word	Definition	Example
Infinitive	In English it is always accompanied by the word "TO". In French, it always ends in ER/IR/RE . E.g: to play, to do, to go, to go out. jouer / faire / sortir	An opinion is always followed by an infinitive: J'aime jouer/ faire/ acheter buy like to play/to do/to
Cognate	A word that is similar in spelling and meaning in two languages	This word is a cognate, what do you think it means? e.g. télé-réalité = TV reality
Connectives	A word that links two sentences or ideas together, e.g. et / cependant	What connective can we use to link these two sentences? <ul style="list-style-type: none"> • j'aime l'histoire (mais) je déteste l'anglais • I like history but I hate English
Intensifiers	A word that strengthens the meaning of other expressions and shows emphasis, e.g. tres/assez	Every time you write an adjective, make sure you use an intensifier before it. <ul style="list-style-type: none"> • je pense que le sport est très important

Example of a French/Spanish LSQ:

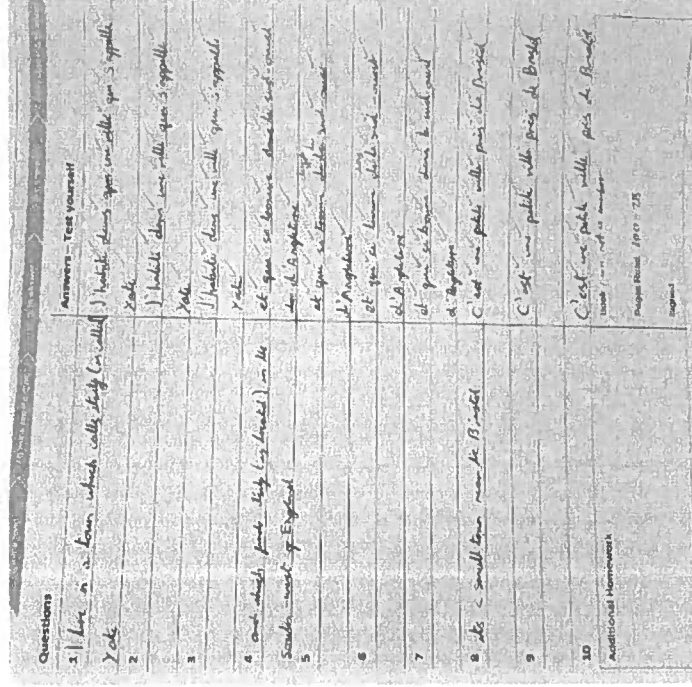

Year 7 Spanish Module 2 – My town + TV & Film

1	I live in a town which is located in the north of France	Vivo en un pueblo que está en el norte de Francia
2	I live in a small house which is located in the west of the United Kingdom	Vivo en una casa pequeña que está en el oeste de Reino Unido
3	Now my region is modern	Ahora mi región es moderna
4	Before my area was big	Antes mi zona era grande
5	On my street there is a cinema and a market	En mi calle hay un cine y un mercado
6	But unfortunately there is no library	Pero desafortunadamente no hay biblioteca
7	From time to time in my province I travel by car to go to school	De vez en cuando en mi provincia viajo en coche para ir al colegio
8	Everyday in my town I go by train to visit my friends	Todos los días en mi pueblo voy en tren para visitar a mis amigos
9	If I had the opportunity I would go by plane to travel the world	Si tuviera la oportunidad iría en avión para viajar por el mundo
10	If I could I would travel by boat to go on holiday	Si pudiera viajaría en barco para ir de vacaciones

Year 7 Spanish Module 2 – My town + TV & Film

11	I love the news because I would say they are interesting	Me encantan las noticias porque diría que son interesantes
12	I don't like horror programmes because they are boring	No me gustan los programas de terror dado que en mi opinión son aburridos
13	My friend likes documentaries, he thinks that they are relaxing	A mi amigo le gustan los documentales, piensa que son relajantes
14	My mother prefers comedies because she thinks they are cheerful	Mi madre prefiere las comedias porque piensa que son alegres
15	Sometimes I watch adventure films on TV	A veces veo las películas de aventura en la tele
16	Normally we watch science fiction films at my friends house	Normalmente vemos las películas de ciencia ficción en la casa de mi amigo
17	Twice a week I like to watch comedy films after school	Dos veces a la semana me gusta ver las películas de comedia después del colegio
18	However, I never watch history films in the evening	Sin embargo nunca veo las películas de historia por la noche
19	But I do not watch a single horror film in the cinema	Pero no veo ninguna película de terror en el cine

Year 7 Spanish Module 2 – My town + TV & Film

20

But I don't watch romance films before school

Pero no veo las películas de amor antes del colegio

MFL key classroom language:

Key Word	Student-friendly definition	Example
Infinite	In English it is always accompanied by the word "TO". In Spanish, it always finishes in "R" (-ar/-er/-ir) E.g: to play, to go to visit, to watch, to go to visit, to play, to go to visit	An opinion is always followed by an infinitive: Me gusta jugar/comprar I like to play/to do/to buy After sueto/solia, you always need an infinitive: suele ver/jugar/descansar I tend to watch/to play/to rest
Cognate	A word that is similar in spelling and meaning in two languages.	This word is a cognate: what do you think it means? E.g. ciclismo = cycling
Connectives	A word that links two sentences or ideas together. E.g. y or otro/otro	What connective can we use to link these two sentences? <ul style="list-style-type: none"> • Me gusta la historia (pero) odio el inglés • I like history but I hate English
Intensifiers	A word that strengthens the meaning of other expressions and shows emphasis. E.g. muy/bastante	Every time you write an adjective make sure you use an intensifier before it. <ul style="list-style-type: none"> • Creo que las ciencias son muy interesantes • I think science is very interesting

Example of a French/Spanish LSO:

Questions	Answers - Test yourself
1. Live in a town which calls itself (a small town)	J'habite dans une petite ville qui s'appelle York
2	J'habite dans une petite ville qui s'appelle York
3	J'habite dans une petite ville qui s'appelle York
4. and which finds itself (a small town)	et qui se trouve dans le sud-ouest de l'Angleterre
5. South-west of England	et qui se trouve dans le sud-ouest de l'Angleterre
6	et qui se trouve dans le sud-ouest de l'Angleterre
7	et qui se trouve dans le sud-ouest de l'Angleterre
8. It's a small town near the Bristol	C'est une petite ville près de Bristol
9	C'est une petite ville près de Bristol
10	C'est une petite ville près de Bristol

RE Year 7 - How did the universe begin?

Key terms:

Creation	The belief that the earth was created by God or gods, or some divine force.
Ex- Nihilo	Out of nothing
Big Bang	The leading explanation about how the universe began.
Evolution	The process by which living things can gradually change over time.
Adaptation	How living things are specialised to suit their environment.
Creation myth (or cosmogonic myth)	is a symbolic narrative of how the world began and how people first came to inhabit it (live in it)
Variation	The differences between living things in a species.

KPI1: To describe tribal myths about the origin of the universe

A Creation myth (or cosmogonic myth) is a symbolic narrative of how the world began and how people first came to inhabit it.

Creation myths often share a number of features.

They often are considered sacred accounts and can be found in nearly all known religious traditions.

They are all stories with a plot and characters who are either deities, human-like figures, or animals, who often speak and transform easily.

KPI3: To review scientific proof to the origin of humanity (human life)

- The basic idea behind the theory of evolution is that different species have developed over time from other life forms.
- The Earth is about 4.5 billion years old and there is scientific evidence that life on Earth began more than three billion years ago.
- The accepted theory of **evolution** explains that it happens by **natural selection**. The key points are
- Individuals in a species show a wide range of variation (differences) and this variation is because of differences in their genes.
- Individuals with characteristics most suited to their environment are more likely to survive and reproduce. The genes that allow these individuals to be successful are passed to their offspring.
- Those that are poorly adapted to their environment are less likely to survive and reproduce. This means that their genes are less likely to be passed on to the next generation.
- Given time, a species will gradually evolve.
- Both genes and the environment can cause variation, but only genetic variation can be passed on to the next generation.

KPI2- To review scientific proof to the origin of the universe

- One of the theories put forward by cosmologists (scientist who study the cosmos/universe) is the **Big Bang theory**.
- This suggests that about 15 billion years ago there was a massive explosion.
- This was the point at which all matter in the universe began; space and time began then too.
- Over time the universe that we know, and human and animal life, emerged.
- This theory is generally accepted by scientists as being the best theory they have to explain the origins of the universe.
- If this theory is true, then it could mean that the universe 'just happened' and that it did not emerge as a result of the activity of a creator God.

RE Year 7 - How did the universe begin?

Key terms:	
Genesis	The Book of Genesis, the first book of the Hebrew Bible and the Christian Old Testament, is an account of the creation of the world
Creationist/ literalist	Also known as fundamentalist Christians, regard the words of the Bible as being the true voice of God.
Liberal	Regard the Bible as words that have been written about God. Although these are a good guide for Christians in understanding their faith, they might interpret passages differently to fit modern society
Cosmological argument	St Thomas Aquinas (1225 – 1274) argued that the order and complexity in the world is proof of a designer and that this designer is God.
Teleological argument	William Paley (1743 – 1805) argued that the complexity of the world suggests there is a purpose to it. This suggests there must be a designer, which he said is God.

KPI4- To explain Christian creation stories about the origin of the universe

Genesis 1:1-2:4 This account tells how God created the world in six days and rested on the seventh.

In the beginning God created the heavens and the earth.

Genesis 1:1 After creating the earth, the sky, the seas and plants, God made birds and fish on the fifth day and animals and humans on the sixth day. "So God created man in his own image, in the image of God he created him; male and female he created them."

KPI 6- To analyse whether science and religion can work together

Cosmological

St Thomas Aquinas (1225-1274)

Everything has to come from something. You cannot make something out of nothing. Therefore, there must have been a 'First Cause' that created the 'something' (the universe).

That **First Cause** is God.

Teleological (or design)

William Paley (1734-1805)

If you were walking on a heath and saw a watch on the ground you would assume that its parts had not come together by chance because it is too ordered and complicated. Therefore, someone must have designed it or it would not work.

Because the universe is also ordered and complicated, someone must have designed that too.

- KPI4- To describe the Genesis account of creation.** The book of Genesis begins "In the beginning God created the heavens and the earth."
- Day 1-2 Water covered earth
 - Day 3 Dry land and plants
 - Day 4 Sun, moon and stars
 - Day 5 Sea and flying creatures
 - Day 6 Land animals and Man
 - Day 7 God rested

KPI5- Different Christian interpretations on creation

Fundamentalist/Literalist Christians believe that as the Bible comes directly from God, everything in it must be the exact truth. For fundamentalist Christians, the Big Bang theory is not correct.

Most believe that God brought the universe into being from nothing. This is sometimes referred to as ex nihilo (out of nothing). Some Christians take the biblical accounts of creation literally, believing that they describe exactly how the universe and human beings were created. Liberal Christians regard these accounts as more like parables or symbolic accounts that tell, in story form, the profound truth that God brought the universe and all that is in it into being, and sustains his creation. These Christians might look to science to help them understand how God did this.

The word 'day' actually meant 'period of time' when the Bible was written. This fact allows some Christians to confirm their beliefs that God caused evolution, as it happened over a very long time.

<https://www.bbc.co.uk/bitesize/guides/zqphw6f/revision/2>

Year 7 - Food Technology (Hospitality and Catering)

Hygiene, Health and Safety

To be ready to cook you need to:	Remove blazer, tie up hair, wash hands, put on an apron, remove watch, have clean nails
When should you wash your hands?	Before putting on your apron, when you changed jobs in the kitchen. After handling raw meat/fish, going to the toilet, coughing/sneezing/blowing your nose, touching rubbish, touching hair or face. Wash hands for 15-20 seconds, use soap and hot water.
The importance of washing up:	Washing up correctly is particularly important for food safety. Cutlery, pans, and dishes which are not washed and rinsed properly provide the ideal conditions for bacteria to grow. This could lead to food poisoning.
Stages of Washing Up:	Move dirty equipment to the dirty side of the sink, run a bowl of hot soapy water, knives are washed, dried, and put away first. Turn dishes and pans upside down on the draining board. Ensure you have a clean area to put your clean equipment. Dry up. Dirty and clean equipment can not get mixed up.

Prevention of Bacteria Growth

4 C's	Chill – foods to be kept in the fridge: dairy, protein, high risk foods / Cook – cook foods properly / Cross Contamination – see above / Clean – see above
Food Temperature Control:	Temperature control is especially important when you buy, store, prepare and cook food. Food correctly stored will minimise the risk of food spoilage and food poisoning. Food poisoning can be caused by high-risk foods when they are stored in warm conditions for too long. Controlling the temperature of food will help keep your food safe until it is ready to be eaten.
Sources of Human Cross Contamination:	Hair, nose, cuts, wounds, ears, throat, clothing, jewellery.
Illnesses to be reported:	Sickness, Diarrhoea, Feeling Sick (Nausea), Colds and Coughs, Ear, Nose and Eye discharges, cuts, boils, septic areas of the body.

Eatwell Guide

Eatwell Guide / Use the Eatwell Guide to help you get a balance of healthier and more sustainable food.	<p>Carbohydrates: Rice, pasta, potatoes, bread, porridge, couscous – Choose wholegrain or higher fibre versions with less added fat, salt and sugar</p> <p>Fruits and Vegetables: Fresh, frozen, dried, canned – Eat at least 5 portions of a variety of fruit and vegetables every day.</p> <p>Protein: Chicken/poultry, fish – fresh and canned (tuna), meat, eggs, chickpeas, lentils, beans. Eat more beans and pulses, 2 portions of sustainably sourced fish per week, one of which is oily. Eat less red and processed meat.</p> <p>Dairy and Alternatives: Milk, yoghurt, cream, cheese, alternative milks: almond, rice, coconut, hazelnut, soya. Choose lower fat and lower sugar options.</p> <p>Fats: Choose unsaturated oils and use in small amounts – sunflower, olive, rapeseed.</p> <p>Sugary foods/crisps/ketchup – eat less often and in small amounts. 6-8 cups of water: lower fat milk, sugar-free drinks including tea and coffee all count.</p> <p>Men: 2500kcal per day/Women 2000kcal per day = All food and drinks</p>
---	---

Glossary of Terms

Glossary of Key Terms:	<p>Food spoilage – when food deteriorates to the point that its quality is reduced or it can no longer be safe to eat. High Risk Foods – Ready to eat moist foods – pasta, rice, seafood, poultry, protein, dairy, sauces/gravy. Cross Contamination – the process by which bacteria or other microorganisms are unintentionally transferred from one substance or object to another, with harmful effects. Hob – top of the oven used to boil, simmer and fry. Grilling – to cook with heat that does not directly touch the food. Rubbing In – to combine fat with flour to make a breadcrumb-like consistency. Creaming – to combine sugar and soft fat (butter). Boiling – to bring water to 100 degrees C. Simmering – to heat liquids to just below the boiling point.</p>
------------------------	---



1. Woods

Man-Made Woods

<p>Medium density fibre board (MDF)</p>	<p>Description</p> <ul style="list-style-type: none"> Has a smooth, even surface Easily machined and painted Available in water and fire-resistant forms Often veneered or painted to improve its appearance 	<p>Uses</p> <ul style="list-style-type: none"> Furniture and interior panelling
<p>Chipboard</p>	<p>Description</p> <ul style="list-style-type: none"> Made from chips of wood glued together with urea formaldehyde (glue) Usually veneered with an attractive hardwood or covered in plastic laminate 	<p>Uses</p> <ul style="list-style-type: none"> Kitchen and bedroom furniture Shelving and general DIY work
<p>Plywood</p>	<p>Description</p> <ul style="list-style-type: none"> Board, consisting of layers of veneer or plies, which are glued together with the grains at 90° to each other Interior and exterior grades available. 	<p>Uses</p> <ul style="list-style-type: none"> Furniture making Boat building and exterior work
<p>Hardboard</p>	<p>Description</p> <ul style="list-style-type: none"> A very cheap particle board Can have a laminated plastic surface 	<p>Uses</p> <ul style="list-style-type: none"> Kitchen unit and furniture back panels

Hard Woods

<p>Oak</p>	<p>Description</p> <ul style="list-style-type: none"> A very strong, light-brown wood Open grained Very hard, but quite easy to work with. 	<p>Uses</p> <ul style="list-style-type: none"> High quality furniture Beams used in building Veneers
<p>Mahogany</p>	<p>Description</p> <ul style="list-style-type: none"> Reddish-brown in colour Easy to work with 	<p>Uses</p> <ul style="list-style-type: none"> Outdoor furniture Shop fittings Bars Veneers
<p>Beech</p>	<p>Description</p> <ul style="list-style-type: none"> A straight, grained hardwood with a fine texture Light in colour Very hard but easy to work with Can be steam bent 	<p>Uses</p> <ul style="list-style-type: none"> Furniture Toys Tool handles
<p>Ash</p>	<p>Description</p> <ul style="list-style-type: none"> Open grained Easy to work with Has cream colour, often stained black Can be laminated (i.e. glued into veneers which are glued together) 	<p>Uses</p> <ul style="list-style-type: none"> Tool handles Sports equipment Furniture Shedders Veneers

Soft Wood

<p>Pine</p>	<p>Description</p> <ul style="list-style-type: none"> Yellowish coloured with dark lines in the grain texture. Medium in weight Stiff and stable Impregnable 	<p>Uses</p> <ul style="list-style-type: none"> Easily available for DIY work Much used for non-structural work and simple joinery Furniture
--------------------	---	---

2. Plastics

<p>Acrylic</p>		<p>Properties:</p> <ul style="list-style-type: none"> Hard wearing Will not shatter Can be coloured Bathrooms, School Projects, Display signs
<p>Polypropylene</p>		<p>Properties:</p> <ul style="list-style-type: none"> High impact strength Softens at 150°C Can be flexed many times without breaking School chairs, Crates
<p>High Impact Polystyrene (HIPS)</p>		<p>Properties:</p> <ul style="list-style-type: none"> Light but strong Widely available in sheets Used for casings of electronic products
<p>Polythene (LDPE)</p>		<p>Properties:</p> <ul style="list-style-type: none"> Weaker and softer than HDPE Lightweight Carrier Bags + Squeezey Bottles
<p>Polythene (HDPE)</p>		<p>Properties:</p> <ul style="list-style-type: none"> Stiff strong plastic Used for pipes and bows Buckets
<p>Urea formaldehyde</p>		<p>Properties:</p> <ul style="list-style-type: none"> Colourless plastic Can be coloured Door and cupboard handles, Electrical fittings

3. Material Properties

<p>Strength</p> <p>The ability of a material to stand up to forces being applied without it bending, breaking, shattering or deforming in any way.</p>
<p>Elasticity</p> <p>The ability of a material to absorb force and flex in different directions, returning to its original position.</p>
<p>Ductility</p> <p>The ability of a material to change shape (deform) usually by stretching along its length.</p>
<p>Malleability</p> <p>The ability of a material to be reshaped in all directions without cracking.</p>
<p>Hardness</p> <p>The ability of a material to resist scratching, wear and tear and indentation.</p>
<p>Toughness</p> <p>A characteristic of a material that does not break or shatter when receiving a blow or under a sudden shock.</p>

3. Metals

<p>Aluminium</p>		<p>Properties:</p> <ul style="list-style-type: none"> Light Weight Light grey in colour Can be polished to a mirror like appearance Rust resistant
<p>Mild Steel</p>		<p>Properties:</p> <ul style="list-style-type: none"> Heavy Dark grey in colour Rusts very quickly if exposed
<p>Stainless Steel</p>		<p>Properties:</p> <ul style="list-style-type: none"> Heavy Shiny appearance Very resistant to wear / rust.
<p>Cast Iron</p>		<p>Properties:</p> <ul style="list-style-type: none"> Has melted pig iron with some quantities of other metals Strong in compression. Brittle
<p>Copper</p>		<p>Properties:</p> <ul style="list-style-type: none"> Reddish brown metal. Soft Excellent conductor of heat and electricity
<p>Brass</p>		<p>Properties:</p> <ul style="list-style-type: none"> Yellow metal Hard Alloy

4. Composites

<p>Carbon Fibre</p>	<p>Expensive in comparison to other materials.</p> <p>Very good strength to weight ratio.</p> <p>Used in the manufacture of high end sports cars and sports equipment.</p>
<p>GRP Fibreglass</p>	<p>GRP is composed of strands of glass which are woven to form a flexible fabric. The fabric is normally placed in a mould and polyester resin is added.</p> <p>Glass reinforced plastic is lightweight and has good thermal insulation properties. It has a high strength to weight ratio</p>

Art Year 7 - Term 2 - Formal Elements/ Portraiture

Formal Elements	Colour Theory	Definition	Examples
<p>Line A mark that connects two or more points. These can be straight, curved, short or long.</p>	Primary Colours	Colours that can't be mixed/ made from other colours.	Red, yellow and blue.
<p>Tone The lightness or darkness or something. For darker tones use a higher grade B pencil.</p>	Secondary Colours	Colours that can be made by mixing two primary colours.	Red + Blue = Purple Yellow + Blue = Green Yellow + Red = Orange
<p>Colour Colour is what you see when light reflects off something.</p>	Tertiary Colours	Colours that can be made by mixing a primary and secondary colour together.	Blue + Green = Turquoise
<p>Texture How something looks or feels e.g. fluffy, rough, smooth etc.</p>	Complementary Colours	Colours that are opposite each other on the colour wheel.	Blue & Orange Red & Green Purple & Yellow
<p>Pattern A symbol, shape or colour that repeats. Man-made patterns are designed by humans, natural patterns are formed by nature.</p>	Analogue/ Harmonious Colours	Colours that are next to each other on the colour wheel.	Red, red-orange and orange
<p>Shape/Form Shape is 2D e.g. rectangles. Form is 3D e.g. cubes, spheres etc.</p>	Tints/ Shades	Tint - Adding white to a colour to make it lighter. Shades - Adding black to a colour to make it darker.	Tint of blue = light blue Shade of blue = dark blue

Tips, Tools & Techniques	Other Keywords	Key Artist	<u>Portraiture Keywords</u>
<p>Blender Stick A paper stump that allows you to blend tones.</p> <p>Blending The smooth transition between tones.</p> <p>Graded Pencils On the side of your pencil you will find letters e.g. H, B or HB. H = Hard led and B = Black which means it has a softer led to give you darker tones, therefore a HB is a good standard drawing pencil.</p> <p>Mark-Making To make your drawings more realistic, you should try to use different marks to show textures and surfaces. You can do this by changing the direction, pressure or length of your marks.</p> <p>Proportion The size and relation of objects to one another. Using the grid-method is one way of helping you draw using accurate proportions.</p>	<p>Observational Drawing Drawing something from real life in front of you.</p> <p>Composition This is where you place objects on a page.</p> <p>Composition Examples: Foreground = closest thing to a viewer Midground = section in between the fore- and background. Background = the furthest thing in the distance to a viewer. Fore-, mid- and background are compositional techniques which help to create distance in a landscape.</p> <p>Cropped = a picture doesn't appear fully as the edges look like they have been cut off.</p> <p>Zoomed in = object is close up and therefore you may only see parts of it.</p> <p>Landscape Painting Landscape art is the depiction of landscapes in art—natural scenery such as mountains, valleys, trees, rivers, and forests. Landscapes are usually wider in layout.</p>	<p>Georges Seurat (1859-91) French painter who was part of the Neo-impressionist art movement and used pointillism as a technique within his work.</p> <p>Art Movement An art movement is a tendency or style in art with a specific common philosophy or goal, followed by a group of artists during a specific period of time.</p> <p>Neo-Impressionist Aim: Applying dots/daps of pure colours (primary colours) straight onto a surface rather than mixing them. The idea is that when you place dabs of blue and yellow close to one another, your eyes then merge these colours together due to their proximity.</p> <p>This technique is called Pointillism.</p>	<p>Proportion In portraits = the size and relation of face features on the face. It is where key features are placed in your drawing to show correct distance between each face feature.</p> <p>Portraiture The art of drawing or taking a photo of a person.</p> <p>Expression Expression means showing an emotion e.g. happy, sad, moody, shocked.</p> <p>Facial Features Eyes, Nose, Mouth</p> <p>Characterisation The distinct features of a person eg things in your portrait that show a trueness to the person's character.</p> <p>Outline A line, generally black, that goes around the outside of an image.</p> <p>Symbolism Using images to suggest specific ideas or feelings e.g. a skull often suggests death.</p> <p>Identity The fact of being who you are.</p>

Drama y7 - Script work

Five Key Acting Skills

Facial Expressions - How can we show emotions through our faces? Eye contact, eye brows, straight, emotions, gritting teeth, tense, relaxed, wrinkled, creased, staring, twitching.

Voice - How can we use our voice in performance? Tone, pitch, pace, emotion, volume, projection, dialogue, dialect, accent, intonation, whistling, SFX, interjection.

Posture - How can we use our bodies to help us create performance? Posture can show emotion, status and age.

Gestures - These are movements with meaning, how can we use them in performance? Hands, arms, speed, clicking, rubbing, waving, mannerisms.

Movement - How can movement be used to create performance? Speed, pace, acceleration, gait, mannerisms, special awareness, stage presence.

Key Terminology

Script - The written words and stage direction which are spoken and performed in a play. A script will be written by a writer and then given to a director to create a performance.

Director - This is the person who is in charge of the actors and performers. The director will tell the actors how they want them to perform and move in each scene. They will block the performance.

Blocking - When creating a performance you must first plan where all the actors are going to be standing and moving to on the stage. You must also plan what set and props are going to be used in your performance. This is called Blocking.

Stage Direction - Text in a script which tells you what you need to be doing while performing. Some scripts may have more stage directions than others. Some directors may also decide not to use all of the stage directions because they have their own ideas for what the performers should be doing.

Character - The people that actors become in a performance

Dialogue - Speech between two or more people

Characterisation - Using a variety of skills, improvisation techniques and background information to become your character. These skills are your 5 key acting skills. It is important you fully understand the character you are performing. You MUST remember, you are no longer yourself when acting. You become someone else.

Performance Discipline - Maintaining extremely high and professional levels of focus and concentration throughout rehearsals and performance. This involves being on task at all times, not laughing or giggling when you are acting. It is crucial to stay focused when performing.

Ensemble - A group of performers all working together in a performance.

Freeze Frame - When a scene 'freezes' for a moment to allow the audience to really explore the moment. It is like pressing pause on live action.

Tableaux - A collection of still images which create a performance. It is like looking through a photo album.

Immersive theatre - Audience are included in the performance but don't know what is going to happen. Actors may talk to or ask the audience questions about what is happening in the performance.

Example Self-evaluation

STRENGTH During my performance, I wanted to show how my character was really angry with another character. To do this, I scrunched my eyebrows together and tilted my head slightly forward, using facial expression to show my annoyance. I also had a very big frown and narrowed whilst making a low pitched noise to display my frustration. This was successful because the audience could clearly see how angry my character was when seeing their friend after having an argument.

AREA FOR IMPROVEMENT During my performance, I wanted to show how my character was really happy to see someone. To do this, I slowly waved my hand and had a slight smile on my face whilst quietly saying 'Hello' in a soft tone. My intention was to show how I was happy but wanted to show it in a subtle way. However, the audience were confused by this and thought that my reaction was too small. If given the chance to perform this moment again, I would make my gestures much bigger, my movements quicker and my facial expressions much more exaggerated so that the audience can see my excitement much more clearly.

PCSHE – Year 7 Term 3 – Diversity and Relationships

Definitions:	The Equality Act	Bullying	For further support:
<ul style="list-style-type: none"> - Stereotypes: thinking all people who belong to a certain group are the same and labelling them, for example all young people who wear hoodies are thugs. - Prejudice: judging someone without knowing them, on the basis of what they look like or what group they belong to, for example all black people are good dancers. - Equality: the state of being equal, especially in status, rights, or opportunities - Protected Characteristics: Protected characteristics are specific aspects of a person's identity defined by the Equality Act 2010. The 'protection' relates to protection from discrimination. - Discrimination: The unfair treatment of someone because of their particular characteristics e.g. race, religion, gender etc. - Hate crime: Any crime can be prosecuted as a hate crime if the offender has either: demonstrated hostility based on race, religion, disability, sexual orientation or transgender identity OR been motivated by hostility based on race, religion, disability, sexual orientation or transgender identity - Gender stereotypes: a generalised view of the characteristics or role that should be held by either gender. - Bullying: Bullying is the repeated and intentional behaviours which cause harm to another person, either physically, emotionally or psychologically. - Banter is the playful exchange of teasing remarks and jokes between friends where all are in on the jokes and enjoy the exchange. - Bystander: A person who doesn't actively engage in the bullying but watches and doesn't do anything to prevent it. - Bully: A person who engages in bullying type behaviour towards one or more people. 	<p>The Equality Act 2010 aims to prevent discrimination or ill treatment. This act was introduced in 2010 to replace all previous equality laws. The new law was intended to help make equality law easier to understand and simpler to use. It is illegal to discriminate against anyone based on nine protected characteristics:</p> <ul style="list-style-type: none"> - Age - Disability - Gender reassignment - Marriage and civil partnership - Pregnancy and maternity - Race: can refer to colour, nationality, ethnic or national origins - Religion or belief: can refer to religious or philosophical beliefs, including a lack of belief - Sex: refers to a person's gender - Sexual orientation <p>Importance of the Equality Act:</p> <ul style="list-style-type: none"> • The Act makes it law that every private, public and voluntary organisation must not discriminate against their employees or the people that use their services because of their characteristics. • The Equalities Act has a huge impact on sentencing in courts. • It is used to make vulnerable groups feel safe. • It is used to help convince people to report crimes and know that the police must take them seriously. • The Equality Act 2010 allows Positive Action so that public bodies (such as schools) can provide additional benefits to some groups to help tackle disadvantage. 	<p>There is no legal definition of bullying. But it is usually defined as repeated behaviour which is intended to hurt someone either emotionally or physically and is often aimed at certain people because of their race, religion, gender or sexual orientation or any other aspect such as appearance or disability.</p> <p>Types of Bullying:</p> <ul style="list-style-type: none"> - Physical: The victim is physically and violently assaulted by the bully. This can include being beaten up, pushed and shoved or the physical taking of items from the victim. This sort of bullying is against the law and should be reported to the police. - Verbal: This can include name calling, snide comments and the spreading of rumours; it can also constitute harassment in some cases which is illegal and should be reported to the police. - Emotional: Psychological and emotional bullying is difficult to see but can include the ostracization of the victim from a particular group, tormenting and humiliating the victim. - Cyber: Cyberbullying is the use of electronic communication to bully a person, typically by sending messages of an intimidating or threatening nature but can also include setting up of malicious websites or posting personal and embarrassing images and videos without the persons permission. - Specific: This the term used to describe bullying based on a specific aspect of the victim's identity such as homophobic, transphobic, Bi-phobic bullying but can also include racist bullying and bullying based on religion. All these types of bullying are illegal. <p>Dealing with Bullying:</p> <ul style="list-style-type: none"> - Remember that it is the victim that determines if they believe the behaviour is bullying not the bully. - Tell someone – don't keep it to yourself, find a trusted adult who you can talk to. - Don't retaliate, try and ignore them if you can. - Try not to react in front of the bully. - Stay with trusted friends who will support you. - If it is cyber bullying - Screenshot evidence of the bullying. Report the bullying to the website and block the user. 	<p>For further support:</p> <ul style="list-style-type: none"> - Your tutor - Mr Hayward - Parents or trusted family members - Another teachers or school staff. - Pastoral Team: Mrs Toulson Mrs Aston - Safeguarding Team: Mr Ogden, Mrs Jones, Mrs Loveridge - The Police - NSPCC Helpline 0800 5000 - www.nspcc.org.uk - Childline: Helpline 0800 1111 - https://www.childline.org.uk - National Bullying Helpline: https://www.nationbullyinghelpline.co.uk - CEOPS - https://www.ceop.police.uk/safety-centre/

PCSHE – Year 7 Term 4 – Your Changing Body

	KPI1: Puberty	KPI3: Body Image	KPI 4: FGM
<p>KPI1 - Key words:</p> <ul style="list-style-type: none"> Puberty: The process of physical maturity in a person that takes place in adolescence Menstruation: Also known as a period. The process in a woman of discharging blood and other material from the lining of the uterus at intervals of about one lunar month from puberty until the menopause, except during pregnancy. Hormones: A chemical substance produced in the body that controls and regulates the activity of certain cells or organs. Wet dream: An involuntary ejaculation that occurs whilst a person is asleep. Body Image: The perception that a person has of their physical self and the thoughts and feelings that result from that perception. Body Confidence: Body confidence is feeling comfortable with your appearance and accepting your body for how it looks and what it can do. Appearance Ideals: The way our society tells us is the ideal or 'best' way to look at a certain point in time. Female Genital Mutilation (FGM): Female Genital Mutilation (FGM) comprises all procedures that involve partial or total removal of the external female genitalia, or other injury to the female genital organs for non-medical reasons. Cellulite: A skin condition that causes dimpling on an area of body. 	<p style="text-align: center;">What is puberty?</p> <p>Puberty is when a child begins to change into an adult. In biological females this is about 8-14 years of age (average 11) and lasts about 4 years. In biological males puberty starts around 9-14 years but takes around 6 years to reach sexual maturity.</p> <p>During this time many changes happen to your body...<u>physically</u> and <u>mentally</u>. Puberty starts when extra amounts of chemicals called hormones start to be produced in the body. The body produces the sex hormones OESTROGEN, PROGESTOGEN and TESTOSTORONE which are responsible for many different changes in the body.</p> <p style="text-align: center;">What changes do our bodies go through during puberty?</p> <ul style="list-style-type: none"> Biological Males: Growing Facial Hair. Voice Breaking. Erections. Wet Dreams. Widenning of chest and Shoulders. Biological Females: Starts between 9 and 11 years of age. Menstruation / Periods begin. Breast growth. Stretch Marks. Cellulite. Hips widen Both: Grow taller. Sweat more. Changes to hair and skin. Spots and Pimples. 	<p style="text-align: center;">KPI3: Body Image</p> <p>Body image is the idea that someone has of their physical self (i.e. body) and the thoughts and feelings that they develop about their body.</p> <p>Factors affecting body image:</p> <ul style="list-style-type: none"> Puberty and the changing body. The Media Peers and Family <p>Ways to promote positive body image:</p> <ul style="list-style-type: none"> Accept Your Body. Remember Nobody's perfect. Don't body-shame yourself. Build a better habit. Like Your Body - Find things to like about your looks. Take Care of Your Body Eat healthy foods. Get a good night's sleep. Be active every day. Keep to a healthy weight <p>Pressure to look a certain way comes from the world around us. It is important to remember images of people that we see in all types of media aren't always real. It is unfair for people to compare themselves to this media.</p>	<p style="text-align: center;">Female Genital Mutilation (FGM): Female Genital Mutilation (FGM) comprises all procedures that involve partial or total removal of the external female genitalia, or other injury to the female genital organs for non-medical reasons.</p> <p style="text-align: center;">What are the effects of FGM?</p> <p>Physical Effects</p> <ul style="list-style-type: none"> Bleeding Urinary tract infections Shock and pain Pregnancy complications Difficulty during childbirth Menstruation problems Painful sex Infertility Tetanus infections Loss of bladder control <p>Emotional Effects</p> <ul style="list-style-type: none"> PTSD Anxiety Trust issues Anger Issues <p>FGM and the Law</p> <ul style="list-style-type: none"> Over 24,000 girls under the age of 15 living in the UK are at risk of undergoing the most severe form of FGM at any one time. Female Genital Mutilation Act 2003 makes it illegal for FGM to be performed in the UK or anywhere in the world on UK citizens or permanent residents of any age. If you carry out or help in carrying out FGM or if you arrange for someone to undergo FGM you face up to 14 years in prison. It is also illegal to take a British national or permanent resident abroad for FGM or to help anyone trying to do this.
<p>Who can you turn to for help and support:</p> <ul style="list-style-type: none"> Tutor Trusted family member or friend Safeguarding team: Mr Ogden, Mrs Jones, Mrs Loveridge. Pastoral Team: Mrs Toulson, Mr Hayward NSPCC: Helpline: 0800 800 5000 (24 hours, every day) nspcc.org.uk ChildLine: Helpline: 0800 1111(24 hours, every day) https://www.childline.org.uk NHS Live Well Website: www.NHS.UK/livewell CEOPS - https://www.ceop.police.uk/safety-centre/ Youth Access - www.youthaccess.org.uk The Mix - www.themix.org.uk Freephone: 0800 808 4994 (13:00-23:00 daily) B-eat - www.b-eat.co.uk Helpline: 0800 801 0711 (Daily 3pm-10pm) Men Get Eating Disorders Too - mengetedstoocoo.uk Anorexia & Bulimia Care - exiabiliacare.org.uk Helpline 03000 11 12 13 (option 1: support line, option 2: family and friends) 			

Year 7 Unit 4 - Programming Essentials part 1

Lesson 1

What are the differences between a computer completing the same task as a human?

Computers need precise commands to be able to go through, they have no prior knowledge or skills that they can use. A human will use prior knowledge and intuition to help them solve a problem.

In computer programming what does the term 'sequence' mean?

A set of instructions performed in order, with each executed in turn.

Give an example of a sequence of instructions. →

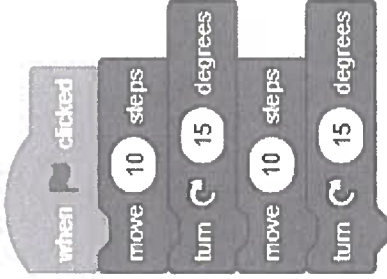

Keywords

Sequencing

Sequencing is the specific order in which instructions are performed

Subroutines

Subroutines are small blocks of code in a modular program designed to perform a particular task

Instructions

A computer instruction is an order given to a computer processor by a computer program.

Execute

To execute a program is to run the program in the computer

Variables

A variable is a value that is stored by a computer.

Input

Data that is entered into or received by a computer

Process

A process or running process refers to a set of instructions currently being processed

Output

The information that it displays on a screen or prints on paper as a result of a particular program.

Storage

Whereas memory refers to the location of short-term data,

Lesson 2

What is a variable?

A variable is a name that refers to data being stored by the computer.

Explain what control flow is?

Control flow refers to algorithms that control the order in which instructions are executed. Normally we use input/process/output to control the flow of instructions in a computer.

Give an example of a variable being used. →

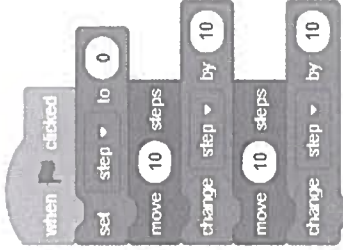

Lesson 3

Explain using an example what a condition is

A condition is an expression that will be evaluated as either true or false.

Explain how condition is used to control the flow of events

When a condition is true program flow will go one way. If the condition is false then program flow will go another way.

Give an example of a selection statement being used in a program. →

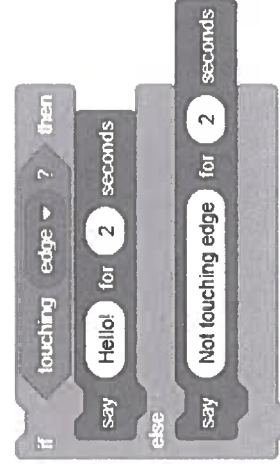

Create conditions that use comparison operators (>, <, =)

In the example shown the user is asked the question "how old are you?". If the answer is greater than 50 then the answer "Please have my seat" is displayed. If the answer is not greater than 50 then "Hello!" is displayed.

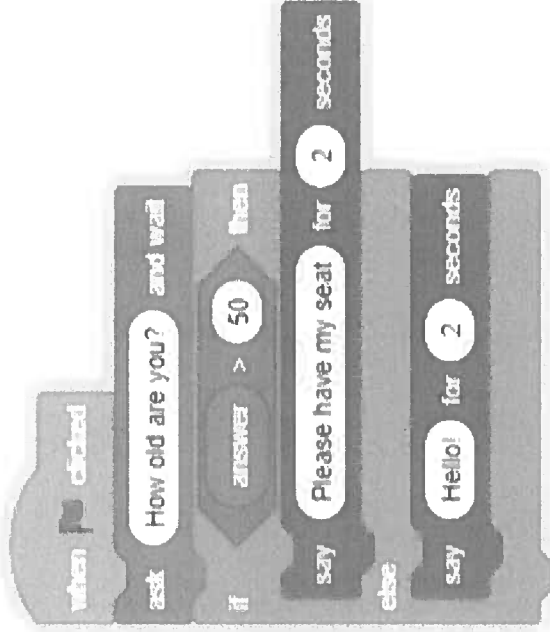

Create conditions that use logic operators (and/or/not)

In the example shown the user is asked the question "how old are you?". This answer is stored in a variable called **age**. The user is then asked "How tall are you". The answer is stored in a variable called **height**.

If **age > 50 AND height > 180** then a message saying "You are old and tall" is displayed. No message is displayed unless both these conditions are true.

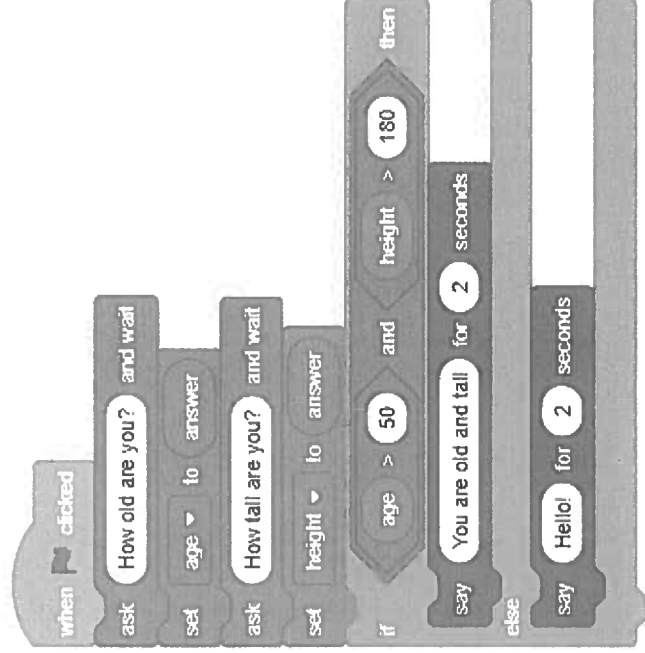

storage is the component of your computer that allows you to store and access data on a long-term basis.

Tracing

To step through the program line-by-line, showing how the variables change

Conditions

Conditions are statements which evaluate if something is true or false.

Selection

Where a section of code is run only if a condition is met

If statements

The IF statement executes one set of code if a specified condition is met (TRUE) or another set of code evaluates to FALSE.

Operators

An operator is a specific mathematical or logical action or process.

Expressions

A combination of values and functions that are combined to create a new value

Iteration

A sequence of instructions or code being repeated until a specific end result is achieved.

What is iteration?

Iteration is a group of instructions that are repeatedly executed

Describe the need for iteration

Computers often have to repeat the same task many thousands of times. By using iteration we make writing computer programs much easier.

Give an example of where count →**controlled iteration can be used.**

The user first selects a times table then another variable count is set to 1. Count is the variable that the selected times table is multiplied by.

Repeat 12 means 12 loops. If the 8 times table is selected the first loop will output count * table or $1 * 8$ which equals 8. At the end of the loop Count is increased by 1 to 2. The second loop multiplies $2 * 8$ as count was increased at the end of the first loop. This continues 12 times and the last output is $12 * 8 = 96$. The loop then stops.

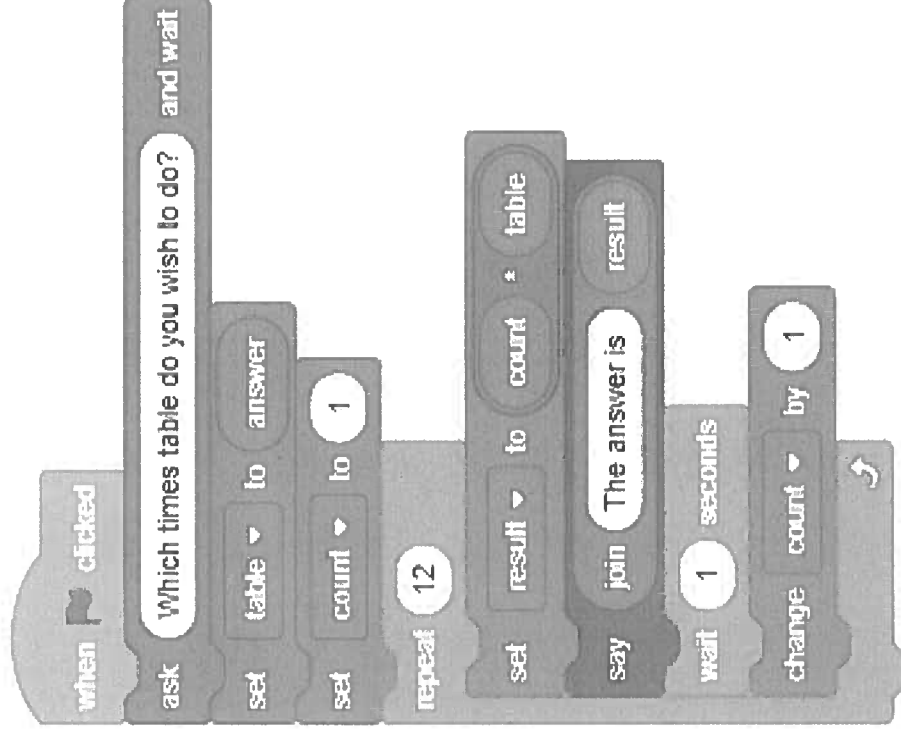
**Count-controlled**

Count-controlled loops are used to make a computer do the same thing a specific number of times.

Condition-controlled

A WHILE or REPEAT loop is repeated based on a certain condition.

Debugging

The process of finding and resolving bugs within computer program

Year 7 Unit 5 - Programming Essentials part 2

Lesson 7

Explain using an example what a subroutine is.

A subroutine is a group of instructions that will run when called by the main program or other subroutines.

Explain what decomposition is.

Decomposition is breaking a problem down into smaller, more manageable subproblems

Identify how subroutines can be used for decomposition

See example here

The image shows a Scratch script for a musical program. The main script starts with a 'when clicked' event block, followed by 'set instrument to (1) Piano'. It then calls four subroutines: 'frere_jacques', 'dormez_vous', 'sonnez_les_matines', and 'ding_dang_dong'. Each subroutine is defined with a 'define' block and a series of 'play note' blocks, each followed by a 'for' loop and a 'beats' value. The 'frere_jacques' subroutine has notes 67, 69, 67, 65, 64, and 60 with beats of 0.25, 0.25, 0.25, 0.25, 0.5, and 0.5 respectively. The 'dormez_vous' subroutine has notes 64, 65, and 67 with beats of 0.5, 0.5, and 0.5. The 'sonnez_les_matines' subroutine has notes 67, 69, 67, 65, 64, and 60 with beats of 0.25, 0.25, 0.25, 0.25, 0.5, and 0.5. The 'ding_dang_dong' subroutine has notes 60, 55, and 60 with beats of 0.5, 0.5, and 0.5, followed by a 'wait 0.5 seconds' block.

Keywords

Subroutine

Subroutines are small blocks of code in a modular program designed to perform a particular task

Decomposition

Breaking down a complex problem or system into smaller parts that are more manageable and easier to understand.

Subproblems

A subproblem is just a (usually smaller!) problem that you solve on the way to solving the problem you're really interested in

Iteration

A sequence of instructions or code being repeated until a specific end result is achieved.

Condition

Conditions are statements which evaluate if something is true or false.

Condition-controlled

A WHILE or REPEAT loop is repeated based on a certain condition.

Identify where condition-controlled iteration can be used in a program.

Where a task needs to be performed repeatedly until a certain condition is met. The repeat loop, below, is an example of conditional control.

Implement condition-controlled iteration in a program

See example here

The repeat loop will continue until the x position of the building < -220. At this point the building leaves the left side of the page and is replaced by a different building on the other side.

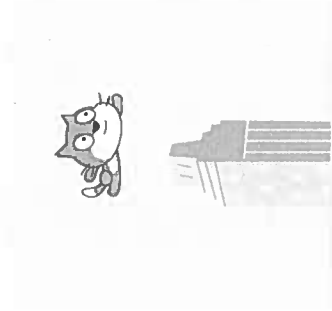

(The cat never moves but because the buildings move from the right to left it makes it look as though the cat is flying.)

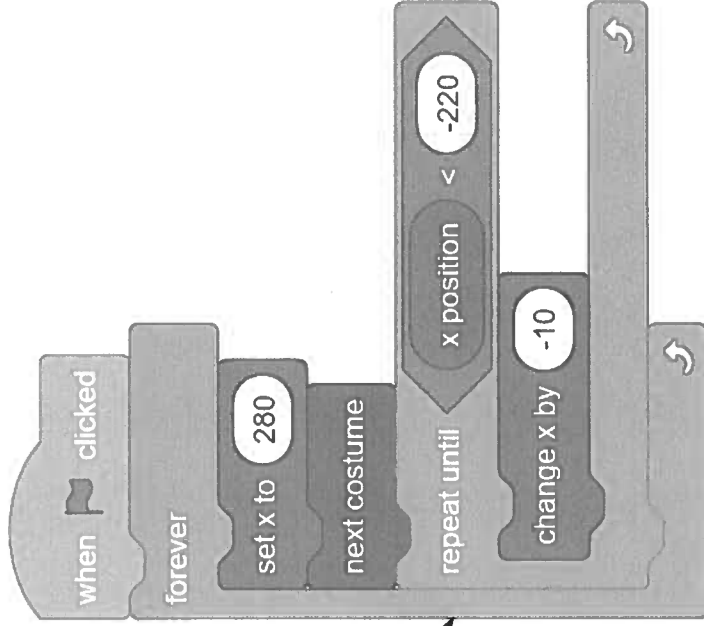

Repeat until

A sequence of instructions is continually repeated until a certain condition is reached.

Count-controlled

Count-controlled loops are used to make a computer do the same thing a specific number of times.

List

A list is several variables, grouped together under a single name.

Variable

A variable is a value that is stored by a computer.

Evaluate which type of iteration is required in a program

To draw a single square use a repeat loop.

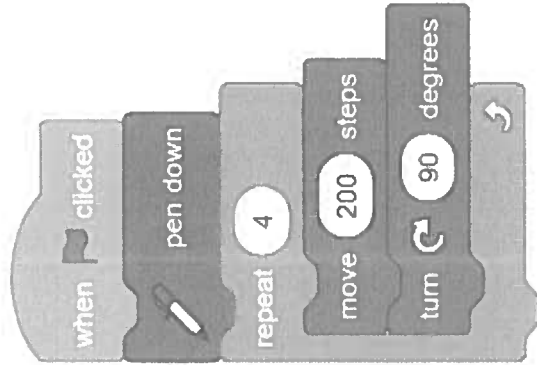

To display a 10 second countdown.

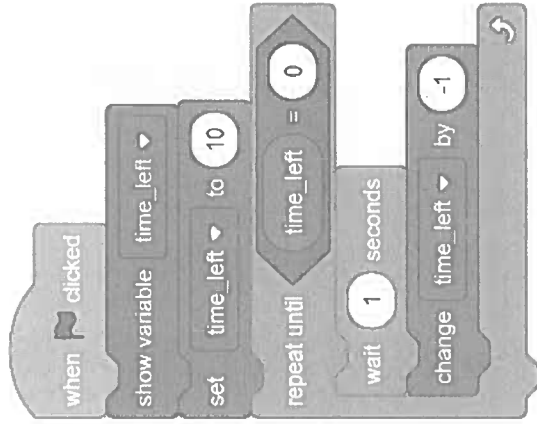

To make a sprite dance until the game is stopped by the user.

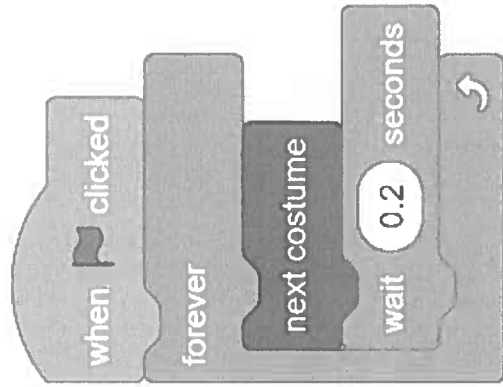

Lesson
10

What is a list in computing?

A list as a collection of related elements that are referred to by a single name. A list can store lots of variables together.

Describe the need for lists.

We need lists as the number of variables in a program can get very big very quickly.
Explain using an example how a list can be used in a program.

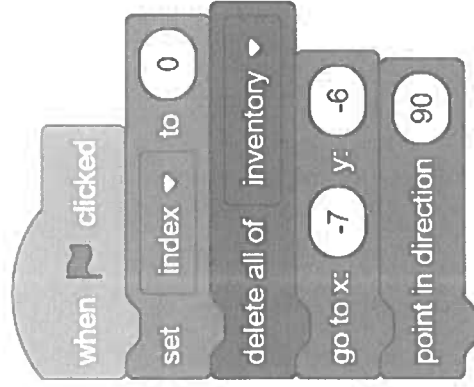

The above code sets a list called inventory to 0, empty, at the start of the game. As scratch, the cat, wanders about anything he touches is added to his list.

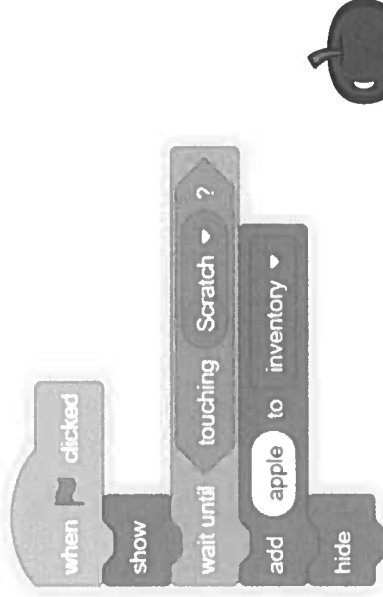

This is the code for the apple. If the apple is touched by scratch then the code adds it to scratch's list.

Lesson
11a &
11b

Explain what is meant by decomposition.

Decomposition is when a large problem is split up into many smaller problems.

Describe how constructs can be used to solve a problem.

Sequence, selection, iteration, subroutines, lists and variables can all be used in such a way that a solution to the problem can be developed.